









-  Magnetic Integrated Connector Modules
-  Compliant with IEEE802.3 standard including 350μH OCL with 8mA DC Bias
-  1500Vrms isolation voltage per IEEE802.3
-  Enhanced performance on EMI suppression with metal shield
-  Support 4 pairs of Category 5 UTP cable with 1000 Base-T full duplex applications
-  Operating temperature 0°C to +70°C
-  UL 1863 listed
-  RoHS compliant versions are available



**GENERAL ELECTRICAL SPECIFICATION @ 25°C**

Insertion Loss (dB Max)		Return Loss <sup>1</sup> (dB Min)		CMRR (dB Min)	Crosstalk <sup>1</sup> (dB Min)	Hipot (Vrms)
0.1-100MHz	100-125MHz	0.5-40MHz	40-100MHz	0.1-100MHz	0.1-100MHz	
1.0	1.2	18.0	12-20Log(F/80)	32.0	33-20Log(F/50)	1500

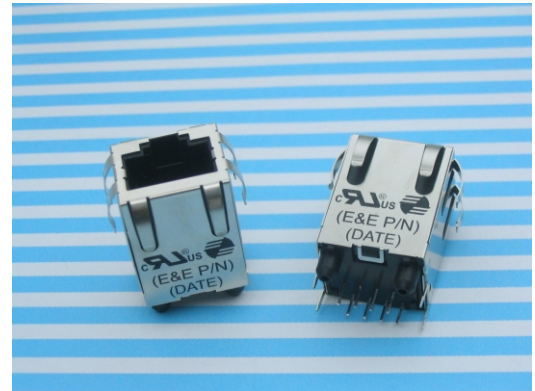
**PART NUMBER TABLE**

Part Number <sup>2</sup>	RoHS Part Number	Turn Ratio (±3%) (Chip : Cable)	Configuration <sup>3</sup>	LED <sup>4</sup> (Left / Right)	Mechanical Package	Schematic
MJ-11V2NNA0-G11K	MJR11V2NNA0-G11K	1CT:1CT	TC	—	MJ11V-02A	G11K
MJ-11V2GYA0-G11U	MJR11V2GYA0-G11U	1CT:1CT	TC	G / Y	MJ11V-02B	G11U

**Notes:**

1. “F” represents the test frequency specified in MHz.
2. For different electrical and mechanical specifications, please contact E&E Magnetic Products Limited.
3. Core location are counted from PCB (Chip) side to Cable (Media) side, where:  
“T” = Isolation transformer ; “C” = Common-mode choke ; “A” = Auto-transformer
4. LEDs (Left / Right) : “G” = Green ; “Y” = Yellow ; “—” = None. For different LED color requirements, please contact E&E Magnetic Products Limited.
5. Panel tabs are optional.
6. All parts shown in this datasheet have gold plating thickness of 10 micro-inch (min.) over contact area.  
Advance options including 30 micro-inch (min.) and 50 micro-inch (min.) are also available.



**MECHANICAL DIMENSIONS**

MJ11V-02A

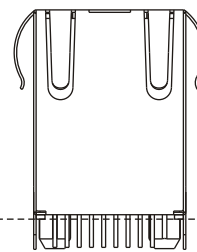
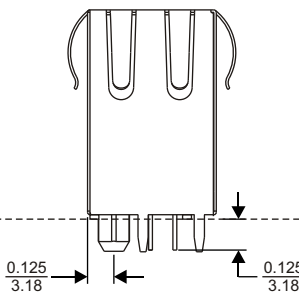
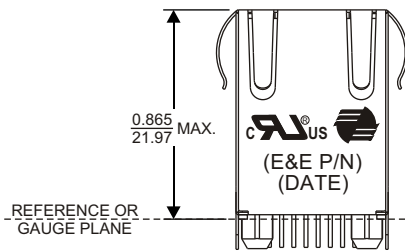
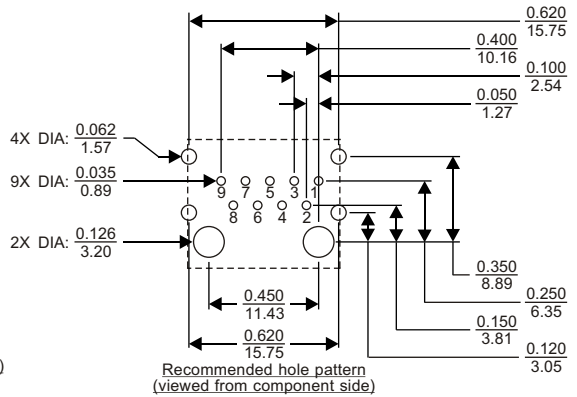
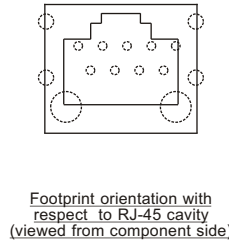
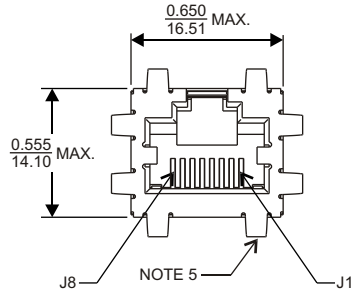

MJ11V-02B

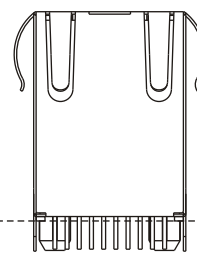
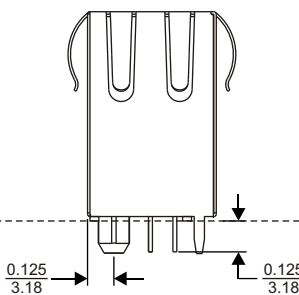
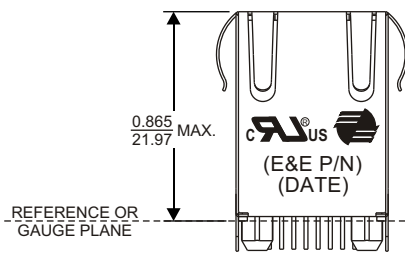
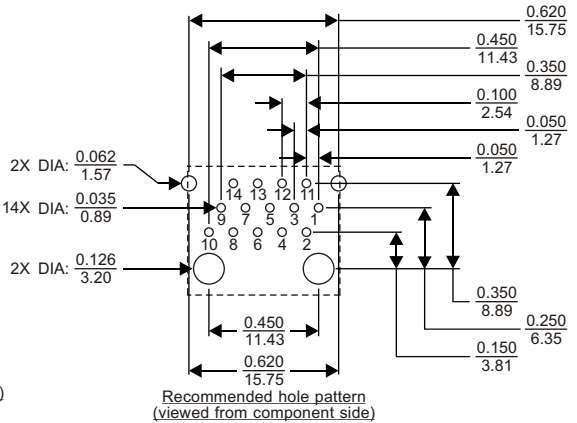
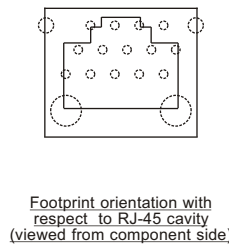
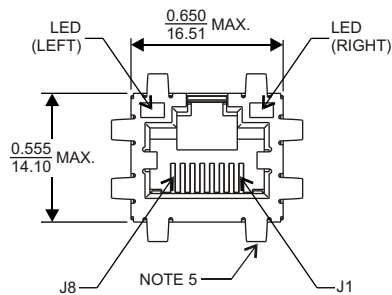

All dimensions are specified in  $\frac{\text{inch}}{\text{mm}}$  with higher precedence in inch.

Unless otherwise specified, all tolerances are  $\pm \frac{0.010}{0.25}$ .

SCHEMATICS

G11K

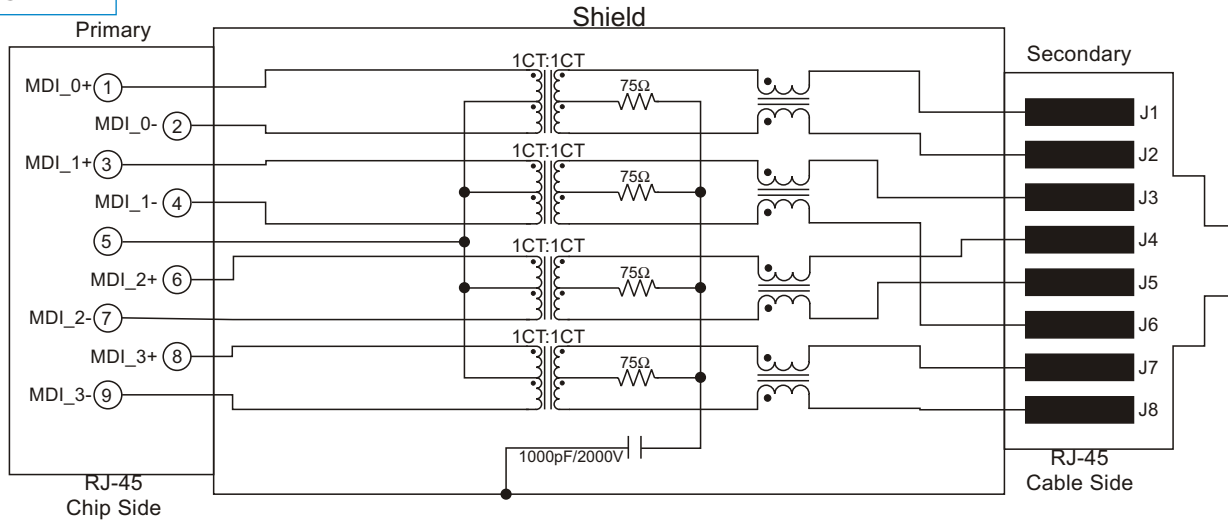

G11U

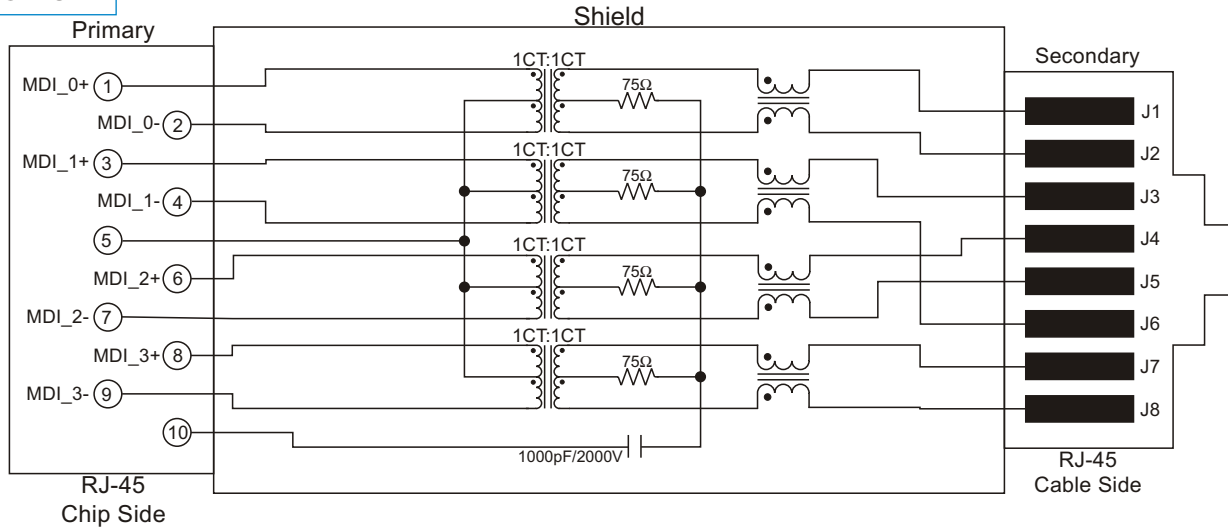

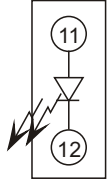
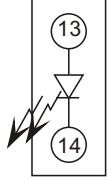

LEDs COLOR AND POLARITY						
MJ11V-02B	LED (LEFT)			LED (RIGHT)		
 LED (RIGHT)	COLOR	POLARITY		COLOR	POLARITY	
		PIN 13	PIN 14		PIN 11	PIN 12
 LED (LEFT)	GREEN	+	-	YELLOW	+	-

LED SPECIFICATION @25°C, FORWARD CURRENT = 20mA			
Standard Color	Typical Wavelength (nm)	Forward Voltage (volt)	
		Typical	Maximum
Green	565	2.2	2.5
Yellow	590	2.1	2.5

MATERIALS	
Housing	Consist of thermoset & thermoplastic materials, all of them are UL 94-V0 rated.
Contact Pins <sup>6</sup>	Phosphor bronze, plated with nickel under-plating and hard gold over contact area.
PCB Pins	Copper wire which meets solderability requirements per MIL-STD-202, method 208.

FOR MORE INFORMATION, PLEASE CONTACT

HEADQUARTER  
2/F Block A, Merit Industrial Centre,  
94 Tokwawan Road, Kowloon,  
Hong Kong  
Tel: (852) 2765 3888  
Fax: (852) 2954 3304  
Email: eempl@eleceltek.com  
Website: <http://www.eleceltek.com>

Information herein is for reference only and subject to change without notice. It does not constitute any representation, warranty or commitment of the company in respect of the products in any aspect. All logos, brands and product names mentioned herein are trademarks or registered trademarks of their respective owners. The company does not assume any liability arising out of the application or use of any product or circuit described herein. Copyrights 2006, E & E Magnetic Products Limited.