







-  Integrated e-field shield eliminates need for separate shielding
-  Handles high transient current spikes without saturation
-  Ideal for noise suppression for motors and LED devices, Excellent DC-DC energy storage up to 2MHz, and Input-Output filter applications
-  Operating temperature -55 C to +155 C
-  RoHS compliant and AEC-Q200 qualified

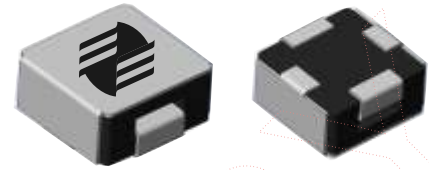

ELECTRICAL SPECIFICATION @ 25°C

Part Number	Inductance ²		Saturation ³ Current Isat (A)	Heating ⁴ Current Idc (A)	DCR (m Ω)		SRF Typ (MHz)	Marking (Axxx)
	Nominal (uH)	Tolerances (%)			Typ	Max		
ARIS7635S-681MF	0.68	±20	17.0	16.5	5.38	5.76	56.1	A681
ARIS7635S-821MF	0.82	±20	16.8	13.8	6.75	7.22	68.6	A821
ARIS7635S-102MF	1.00	±20	13.0	12.0	7.90	8.45	53.2	A102
ARIS7635S-152MF	1.50	±20	11.6	10.6	12.3	13.2	45.9	A152
ARIS7635S-222MF	2.20	±20	10.8	8.1	17.1	18.3	31.2	A222
ARIS7635S-332MF	3.30	±20	8.3	6.8	26.5	28.4	28.6	A332
ARIS7635S-472MF	4.70	±20	5.6	5.6	35.9	38.4	25.5	A472
ARIS7635S-562MF	5.60	±20	4.8	5.3	42.6	45.6	22.8	A562
ARIS7635S-682MF	6.80	±20	4.4	4.4	53.8	57.6	19.6	A682
ARIS7635S-103MF	10	±20	2.9	4.0	71.9	76.9	14.0	A103
ARIS7635S-153MF	15	±20	2.8	2.9	118	127	10.4	A153
ARIS7635S-223MF	22	±20	2.2	2.8	163	174	8.3	A223

Notes:

1. Ordering Information: ARIS7635S - bbbaFc.
ARIS7635S= Product Type.
a = Tolerance of Inductance (M = ± 20%).
bbb = Inductance value in uH (i.e. 471 = 0.47uH; 102 = 1.00uH; 222 = 2.2uH).
F = Internal Control Code.
c = Packaging Code (T = Tape & Reel Packaging in 13 inch Reel).
2. Inductance is tested at 0.25Vrms, 100kHz @ 0Adc.
3. Saturation current, Isat, indicates the value of DC current when the inductance is 20% (typical) lower than its initial value at an ambient temperature of 25°C.
4. Heating current, Idc, is the current required to raise the component temperature by approximately 40°C. The heating current is determined by mounting the component on a typical PCB and applying current for 30 minutes.
5. Operating temperature range: -55°C to +155°C.
6. The part temperature (ambient temperature + temperature rise) should not exceed the upper limit of the operating temperature under worst case operating conditions. Circuit design, component placement, PWB trace size and thickness, airflow and other cooling provisions all affect the part temperature. Part temperature should be verified in the end application.



MECHANICAL DIMENSIONS

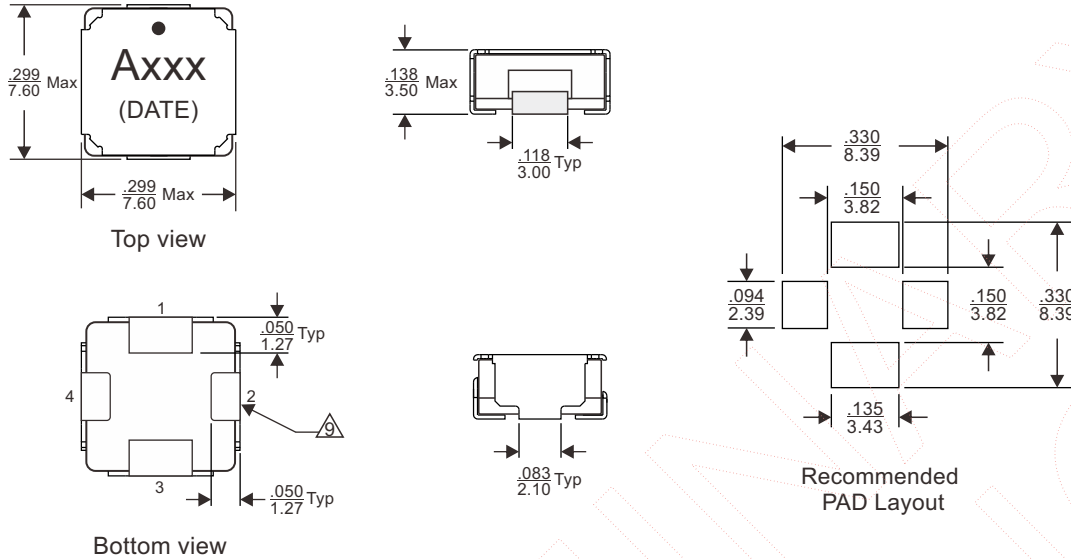

Notes:

- 7. All dimensions are specified in $\frac{\text{inches}}{\text{mm}}$ with higher precedence in mm.
- 8. Unless otherwise specified, all tolerances are $\pm \frac{.010}{0.25}$.
- 9. Maximum E-field reduction realized with a covered-clip (Pin 2 & 4) is connected to ground.

Weight (in gram)	: 0.8 typ.
Tape & Reel	: 1400 / reel

SCHEMATIC



PACKAGING

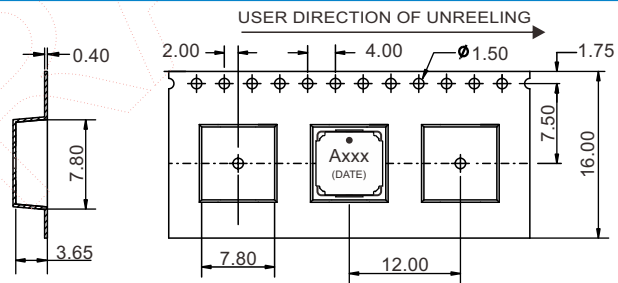

FOR MORE INFORMATION, PLEASE CONTACT

HEADQUARTER
 Flat G, 5/F, Valiant Industrial Centre,
 2-12 Au Pui Wan Street, Fotan, Shatin, N.T.
 Hong Kong
 Tel: (852) 2954 3027 Fax: (852) 2303 9120
 Email: eempl@eleceltek.com
 Website: <http://www.eleceltek.com> / www.eemagnetic.com

Information herein is for reference only and subject to change without notice. It does not constitute any representation, warranty or commitment of the company in respect of the products in any aspect. All logos, brands and product names mentioned herein are trademarks or registered trademarks of their respective owners. The company does not assume any liability arising out of the application or use of any product or circuit described herein. Copyrights 2009, E & E Magnetic Products Limited.