

1 Green-Cap(ELECTRIC DOUBLE LAYER CAPACITORS)

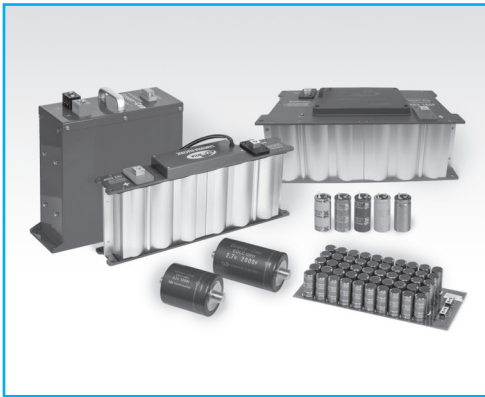

Green-Cap (ELECTRIC DOUBLE LAYER CAPACITORS)

Electric double layer capacitor(EDLC) is a next-generation energy storage device. In recent years, there has been much exploration of new uses for EDLC, and it is expected that they will become even more commonly used in the future.

What is electrical double layer capacitor (EDLC)?

A conventional capacitors have a dielectric sandwiched between two opposing electrodes. An aluminum electrolytic capacitor, as an example, uses an aluminum oxide film as a dielectric. However, EDLC does not have a dielectric. EDLC uses the electric double layer to function as the dielectric of activated carbon, therefore EDLC does not use a chemical reaction such as a redox reaction but rather store electricity by means of the physical adsorption of ions to the large specific surface area of activated carbon. EDLC consists of environmentally friendly active carbon and an organic solvent, whereas a conventional battery is made from heavy metals such as lead. EDLC does not harm the environment.

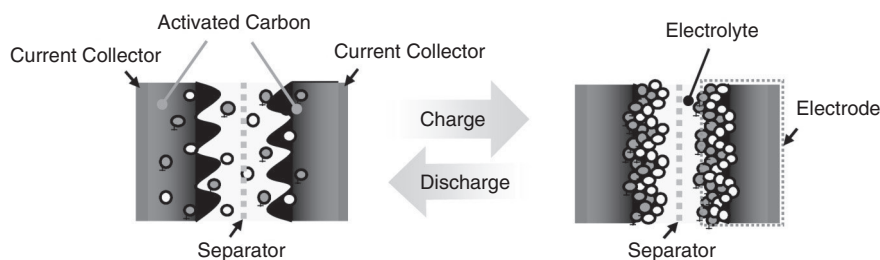

Electric Double Layer Capacitor Principle

Product Features

- ▷ Stable charge and discharge cycle
 - Life is not affected by charging/discharging cycles because there is no chemical reaction
- ▷ The advantages of EDLCs over rechargeable batteries
 - Very safe, No risk of explosion or ignition
 - Environmentally-friendly, with no heavy metals used
 - Rapid charging and discharging (at heavy current)
 - Long cycle life, charging / discharging tens of thousands of times
 - Wide range of temperatures, operation even at low temperatures
 - Recycling is unnecessary (required for batteries)
- ▷ Character of Energy Storage Device

Section		EDLC	Ni-MH	LiB
Voltage (Operating Range)		2.7 (2.7 ~ 0)	1.2 (1.4 ~ 0.9)	3.7 (4.2 ~ 3.0)
Operating Temperature Range		-40 ~ 65°C	Charge : 0 ~ 45°C	Charge : 0 ~ 45°C
High Temperature Spec.	Test Condition	Max. Operating Temp. and Max. Operating Voltage	Cycle life by Temperature	Max. Operating Temp. and Max. Operating Voltage
	Guarantee	1500hrs	0 ~ 20°C: 500 cycle	168hrs
Electrolyte	Solvent	AC / PC	KOH	EC
	Salt	Salt		LiPF6
Dangerous		None	Corrosiveness	Firing, Explosion
Eco - friendly		Very good	Good	Bad

Technical Data

CHART 1

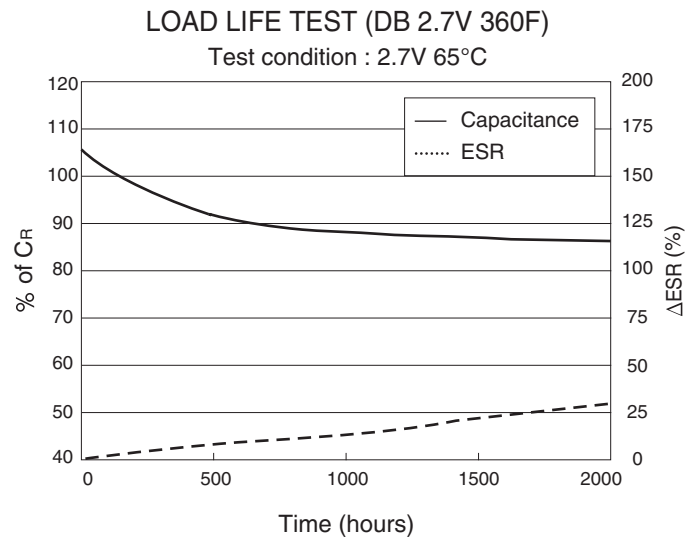
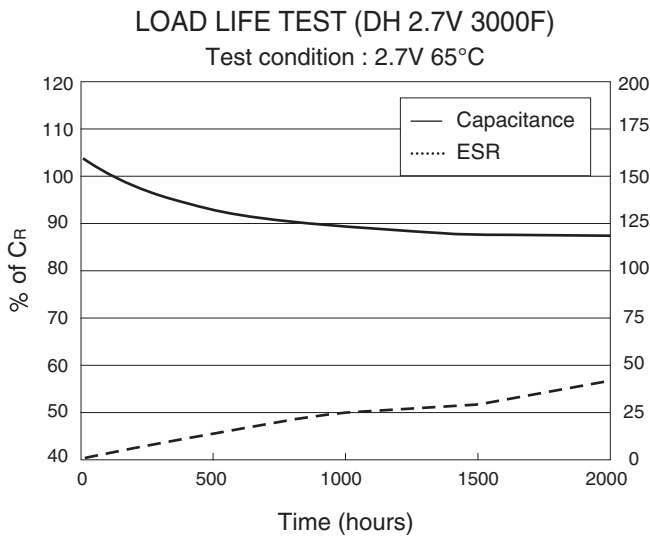

CHART 2

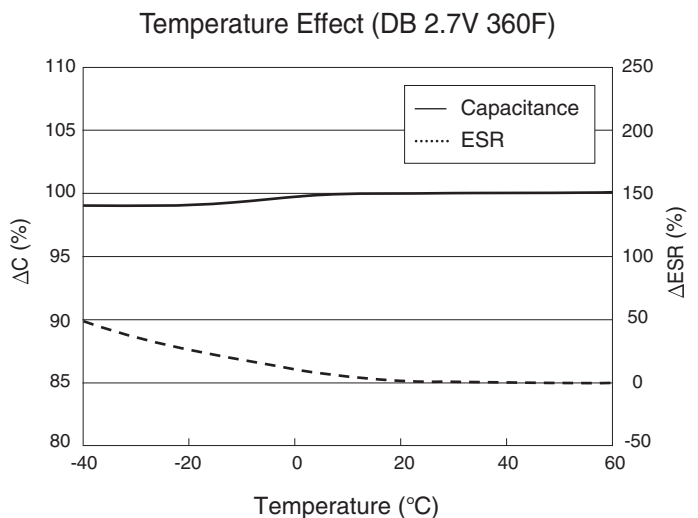
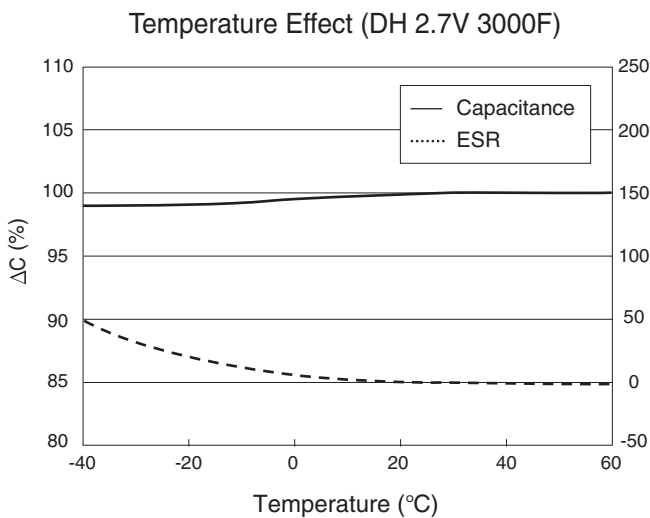
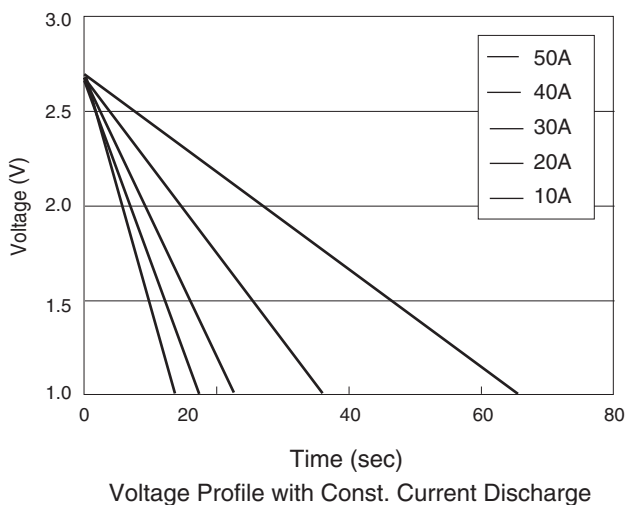
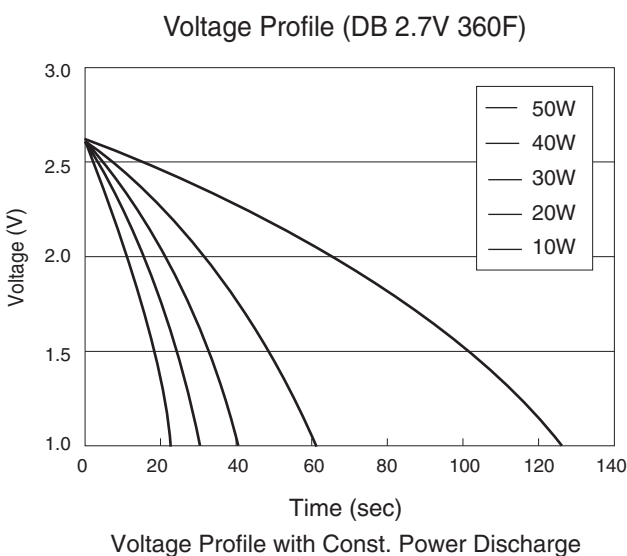

CHART 3



Application Guidelines

1. Polarity

Be sure verify the polarity of the capacitor before use. If a reverse voltage is applied for a long time, capacitor lifetime is shortened and serious damage such as electrolyte leakage may occur.

Further more, there may be leftover electric charge from capacitor testing that could damage other circuit components such as the low-withstanding voltage parts of semiconductors, etc.

2. Voltage

If a Green-Cap is used at a voltage exceeding its rated voltage, not only is its life shortened, but depending on the actual voltage, gas generated by electrochemical reactions inside the capacitor may cause it to leak or rupture

3. Ambient Temperature

(1) Capacitor life is affected by operating temperature. In general, lowering ambient temperature by 10°C will double the life of a capacitor. Use the capacitor at the lowest possible temperature under the maximum guaranteed temperature.

(2) Operation above the maximum specified temperature not only shortens capacitor life, but can also cause serious damage such as electrolyte leakage.

Verify the operating temperature of the capacitor by taking into consideration not only the ambient temperature and temperature inside the unit, but also the radiation from heat generating elements inside the unit (power transistors, IC's, resistors, etc.) and self-heating due to ripple current.

Be careful not to place heat-generating elements across from the capacitor on the opposite of the PCB.

4. Ripple Current

Green-Cap has a higher internal resistance than do electrolytic capacitors and are more susceptible to internal heat generation when exposed to ripple current. When the temperature of the element rises, a reacting current flows inside the Green-Cap, generating reaction products and raising internal resistance even further. This makes it difficult to maintain capacitance. Set the allowable limit for the ripple current-induced rise in capacitor temperature to 3°C measured at the surface of the capacitor

5. Heat Stress During Soldering

Excessive heat stress may result in the deterioration of the electrical characteristics of the capacitor, loss of air-tightness, and electrolyte leakage due to the rise in internal pressure

(1) If the tip of the soldering iron touches the capacitor's external sleeve, the sleeve will melt or break.

(2) Use the general reference chart below to set soldering temperature and time.

(3) When soldering with a soldering iron, do not touch the tip to the body of the capacitor.

Minimize the time that soldering iron is in contact with the capacitor terminals.

(4) When using equipment such as a UV curing oven for pre-heating and adhesive hardening, do not set the temperature above 150°C.

If the temperature is higher than this, the external sleeve may crack and the end seal may suffer reduced performance.

(5) Never perform reflow soldering on Green-Cap using infrared or atmospheric methods.

6. Circuit Board Cleaning

Circuit board can be immersed or ultrasonically cleaned using suitable cleaning solvents for up to 5 minutes and up to 60°C maximum temperature. The board should be thoroughly rinsed and dried. Recommended cleaning solvent include. Pine Alpha ST-100S, Sunelec B-12, DK beclear CW-5790, Aqua Cleaner 210SEP, Cold Cleaner P3-375, Telpen Cleaner EC 7R, Clean-thru 750H, Clean-thru 750L, Clean-thru 710M, Techno Cleaner 219, Techno Care FRV-1

- Consult with us if you are using a solvent other than any of those listed above
- The use of ozone depelting cleaning agents are not recommended in the interest of protecting the environment

7. CONNECT IN SERIES

Voltage balancing is needed to ensure uniform voltage distribution across each capacitor, if capacitors are connected in series to gain higher rated voltage.

8. CONSIDERATION TO ASSEMBLY CONDITION

In designing a circuit, the following matters should be ensured in advance to the capacitor's assembly on the printed wiring board (PW board).

Design the appropriate hole spacing to match the lead pitch of capacitors.

Do not locate any wiring and circuit patterns directly above the capacitor's vent.

Ensure enough free space above the capacitor's vent. The recommended space is specified in the catalog or specification sheets.

In case the capacitor's vent is facing the PW board, make a gas release hole on PW board.

The sealing side of the screw terminal type should not face down in the application.

When the capacitors are mounted horizontally, the anode screw terminals must be positioned at the upper side.

9. STORAGE

(1) Capacitors should not be stored in high temperatures or where there is a high level of humidity. The suitable storage condition is 5°C~35°C and less than 75% in relative humidity.

(2) Capacitors should not be stored in damp condition such as water, saltwater spray or oil spray.

(3) Do not store capacitors in an environment full of hazardous gas (hydrogen sulfide, sulfurous acid gas, nitrous acid, chlorine gas, ammonia or bromine gas).

(4) Capacitors should not be stored under exposure to ozone, ultraviolet rays or radiation.

(5) In order to maintain a good solderability of the parts, shelf life of parts should not exceed 1 year.

(6) When the capacitor is stored for a long time without applying voltage, leakage current tends to increase.

This returns to nominal by applying voltage. Apply voltage (Aging) before use if the capacitor is stored long time.

It is recommended to apply DC working voltage to the capacitor for 30 minutes.

10. TECHNICAL INFORMATION

Capacitance, DCESR Test Condition :

Constant current charge with 10mA/F to V_R .

Constant voltage charge at V_R for 5 min.

Constant current discharge with 10mA/F to 0.4 V_R .

Max. Peak Current : Current for 1 sec discharge from the rated voltage to the half of it in constant current discharge, The stated maximum (peak current) should not be used in normal operation and is only provided as a reference value.

$$I = \frac{1/2 V_R}{\Delta t / C + ESR_{DC}}$$

Energy

$$\text{Max. Stored Energy (Wh), } E_{max} \text{ (Wh)} = \frac{1/2 CV_R^2}{3600}$$

$$\text{Specific Energy (Wh/kg)} = \frac{E_{Max}}{\text{weight}}$$

Cycle Life Test Condition

- 1-minute cycle at room temperature
- Constant current charge from $1/2V_R$ to V_R .
- Constant current discharge from V_R to $1/2V_R$.
- Repeat the cycle for the desired number of times.

PART NUMBER SYSTEM

● Single Cell Part Number System

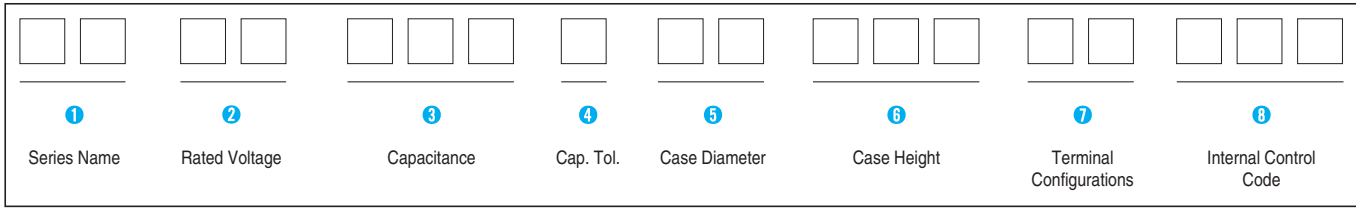

1 Series Name
See page 6.

2 Rated Working Voltage

WV	2.5	2.7	2.85	3.0
CODE	0E	5U	5R	0U

3 Capacitance

ex)

1F	105
10F	106
100F	107
1000F	108

4 Capacitance Tolerance

Tolerance (%)	±20	0~20%
Code	M	W

5 Case Diameter

ex)

∅10	10
∅16	16
∅18	18

6 Case Height

ex)

20mm	020
25mm	025
30mm	030

7 Terminal Configurations

Terminal Configurations	Code
Radial Type(LEAD)	BB
Snap-In for Soldering	HA
Lug Terminal for Soldering	LG
Screw Terminal Type	SB
Threaded Terminal Type	TH
Weldable Terminal Type	WD

● Module Part Number System

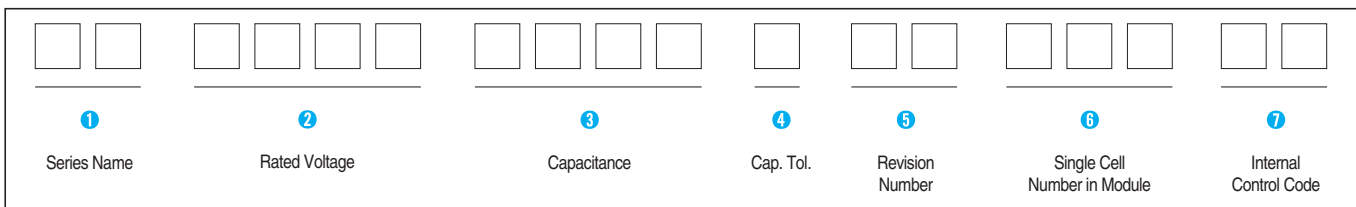

1 Series Name
See page 6.

2 Rated Working Voltage

ex)

5.0V	0050
13.5V	0135
135V	1350

3 Capacitance

ex)

1.6F	0016
16F	0160
160F	1600

4 Capacitance Tolerance

Tolerance (%)	0 ~ +20
Code	W

5 Revision Number

ex) 01, 02

6 Single Cell Number in Module

ex) 10ea 010

PACKING

● BLUCK TYPE PACKING

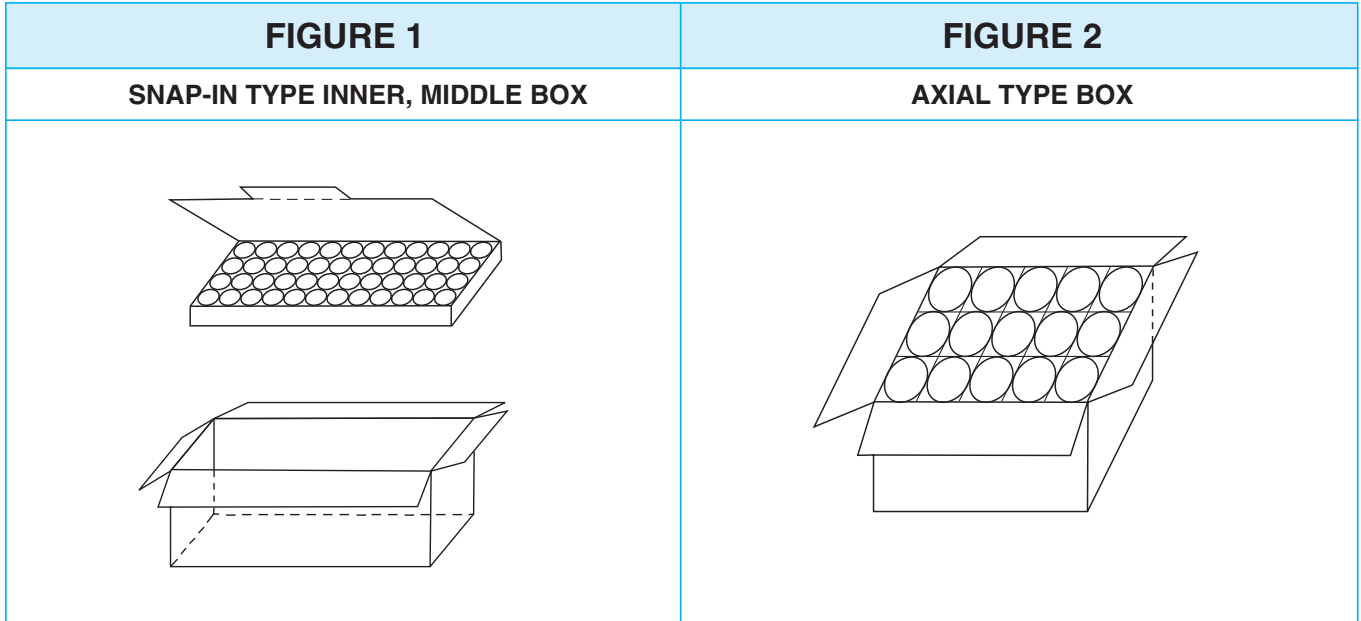

● SNAP-IN TYPE PACKING Quantity (pcs) / BOX (FIGURE 1)

SIZE		SNAP-IN(QUANTITY)	
ØD	L	INNER BOX	MIDDLE BOX
22	35, 45, 47	150	450
30	45	50	200
	60	50	150
35	50 ~ 85	50	150

● AXIAL TYPE PACKING Quantity (pcs) / BOX (FIGURE 2)

SIZE		AXIAL(QUANTITY)
ØD	L	
60	51 ~ 138	20

● RADIAL TYPE PACKING

● PACKING QUANTITY (pcs) / BOX

SIZE		BULK(QUANTITY)		
ØD	L	V-Bag	INNER BOX	MIDDLE BOX
8	20	300	2400	9600
10	20	200	1600	6400
	30	200	1200	4800
12.5	25	100	900	3600
16	25	50	500	2000
18	32	50	400	1600
	40	50	300	1200
22	45	50	150	600

Green-Cap (ELECTRIC DOUBLE LAYER CAPACITORS)

DM Green-Cap Module

- Low internal resistance
- Balancing and overvoltage protection of individual cell
- Efficient heat transfer to outside

Application

- Next Generation Vehicle(FCEV, HEV) & Heavy Duty Transportation
- Short term UPS and telecommunications
- Portable Power Tool
- Wind Turbine Pitch System
- Electric Scooter
- Heavy Duty Transportation
- Golf Car

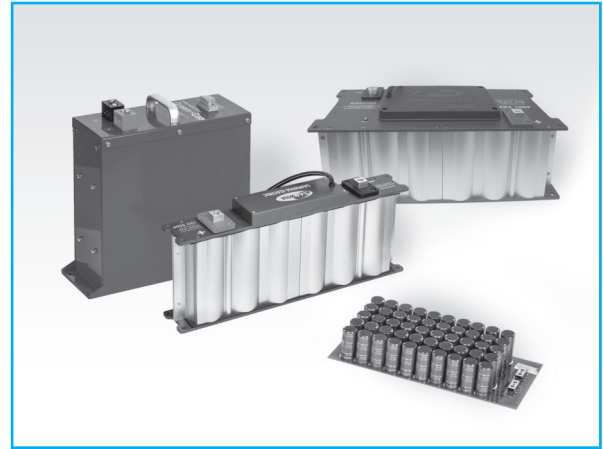

● Product & Spec.

Item	Characteristics	
Capacitance tolerance	0% ~ +20%	
Operating temperature range	-40 ~ +65°C, -40 ~ +85°C	
Storage Temperature Range	-40 ~ +70°C	
Temperature characteristics	Capacitance change	Within ±5% of initial value at +20°C
	Internal resistance change	Within 150% of initial value at +20°C
Endurance (65°C)	Test time	1500 hours (5.4V products are for 1000 hours)
	(1) Capacitance change	▲ Within ±30% of initial specified value
		● Within ±20% of initial specified value
(2) Internal resistance change	Less than 100% of specified value	
Shelf life (65°C)	After 1500 hours no load test same as endurance	
Life Time at RT ⁽¹⁾⁽²⁾ (held continuously at Rated Voltage)	10 years	
Cycle Life (25°C) ⁽¹⁾⁽²⁾	▲	500,000 cycles
	●	1,000,000 cycles

(1) | ΔCI < 30% and ΔESR < 200% of initially specified value, respectively and LC < specified value
(2) Cycle : between rated voltage and half rated voltage under constant current at 25°C

Part Number	Rated Voltage	Capacitance (F)	ESR, 1KHz (mΩ)	ESR, DC (mΩ)	Max. Continuous Current (A)		Max. Peak Current	Max. Stored Energy (Wh)	Specific Energy (Wh/kg)	Dimension(mm)			Weight (kg)	Cycle Life
					ΔT=15°C	ΔT=40°C				L	W	H		
DM00540015W01002	5.4	1.5	120	180	0.2	0.33	3.2	0.006	1.79	22.0	8.5	16.5	0.003	▲
DM00540025W01002	5.4	2.5	100	140	0.33	0.55	5.0	0.010	2.03	22.0	10.5	21.0	0.005	▲
DM00540050W01002	5.4	5.0	60	100	0.65	1.09	9.0	0.020	2.89	32.0	10.5	21.0	0.007	▲
DM01500666W01006	15	66.6	23.0	27.4	12	20	191.0	2.08	2.60	247	46	76	0.8	▲
DM01622000W01006	16.2	200	2.5	3.6	84	10	941.8	7.29	1.78	418	68	115	4.1	●
DM01622666W01006	16.2	266.6	2.2	3.2	90	150	1165.4	9.72	2.11	418	68	126	4.6	●
DM01623333W01006	16.2	333.3	1.8	2.5	100	167	1472.7	12.15	2.38	418	68	143	5.1	●
DM01625000W01006	16.2	500	1.4	2.0	120	200	2025.0	18.23	3.04	418	68	179	6	●
DM04860666W01018	48.6	66.6	7.6	10.8	84	140	941.8	21.87	2.19	418	191	115	10	●
DM04860888W01018	48.6	88.8	6.5	9.7	90	150	1165.4	29.16	2.54	418	191	126	11.5	●
DM04861111W01018	48.6	111.1	5.4	7.6	100	167	1472.7	36.45	2.92	418	191	143	12.5	●
DM04861666W01018	48.6	166.6	4.3	6.0	120	200	2025.0	54.68	3.65	418	191	179	15	●
DM07500360W01090	75	36	38.4	45.6	12	20	511.0	28.13	2.25	460	153	282	12.5	▲
DM09000100W01036	90	10	138.2	164.2	12	20	170.3	11.25	1.41	290	110	268	8	▲
DM12960625W01048	129.6	62.5	11.5	16.1	120	200	2025.0	145.80	2.43	713	496	222	60	●

Note : Other Green-Cap modules are supplied on custom-made basis. Dimension and Weight could be changed.
The contents of this document are subject to change without notice.

DH Axial Type, Standard Series

- High Power Density
- Rapid charge and discharge
- Ultra-low internal resistance



Item	Characteristics	
Operating temperature range	-40 ~ +65°C	
Rated Voltage	2.7 VDC	
Capacitance tolerance	0% ~ +20%	
Temperature characteristics	Capacitance change	Within $\pm 5\%$ of initial value at +20°C
	Internal resistance change	Within 100% of initial value at +20°C
Endurance (65°C)	Test time	1500 hours
	Capacitance change	Within $\pm 20\%$ of specified value
	Internal resistance change	Less than 100% of specified value
Shelf life (65°C)	After 1500 hours no load test same as endurance	
Life Time at RT ⁽¹⁾	10 years	(1) $I \Delta C I < 20\%$ and $\Delta ESR < 100\%$ of specified value, respectively and $LC <$ specified value
Cycle Life (25°C) ⁽¹⁾⁽²⁾	1,000,000 cycles	(2) Cycle : between rated voltage and half rated voltage under constant current at 25°C

● DRAWING

Unit : mm

Threaded Type

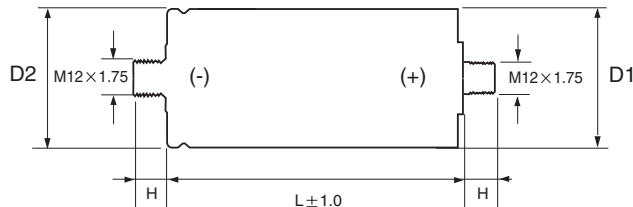
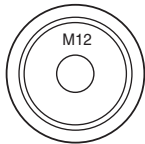

Size (mm)		
H	D1	D2
(±0.2)	(±0.2)	(±0.5)
13.0	∅60.4	∅60.7

Weldable Type

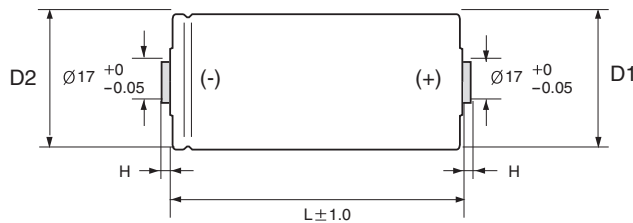

Size (mm)		
H	D1	D2
(±0.2)	(±0.2)	(±0.5)
3.0	∅60.4	∅60.7

● CHARACTERISTIC LIST & DIMENSIONS

Rated Voltage	Capacitance (F)	ESR, 1KHz (mΩ)	ESR, DC (mΩ)	LC (72hr) (mA)	Max Continuous Current(A)		Max Peak Current(A)	Specific Energy		Weight (g)	Volume (ml)	Dimension ∅D × L(mm)
					ΔT=15°C	ΔT=40°C		(Wh/kg)	(Wh/L)			
2.7	1200	0.30	0.33	2.7	98	159	1160	4.05	5.73	300	212	60.4 × 74
	1600	0.25	0.28	3.0	115	188	1492	4.76	6.65	340	244	60.4 × 85
	2000	0.24	0.27	4.0	126	206	1753	5.06	6.93	400	292	60.4 × 102
	3000	0.20	0.23	5.0	150	245	2396	5.79	7.68	525	395	60.4 × 138
	3400	0.25	0.28	9.2	130	210	2351	6.50	8.71	530	395	60.4 × 138

Green-Cap (ELECTRIC DOUBLE LAYER CAPACITORS)

DV Axial Type, High Voltage Series

- High Power Density
- Rapid charge and discharge
- Ultra-low internal resistance

DH \Rightarrow DV
High Voltage



Item	Characteristics	
Operating temperature range	-40 ~ +65°C	
Rated Voltage	2.85, 3.00 VDC	
Capacitance tolerance	0% ~ +20%	
Temperature characteristics	Capacitance change	Within $\pm 5\%$ of initial value at +20°C
	Internal resistance change	Within 100% of initial value at +20°C
Endurance (65°C)	Test time	1500 hours
	Capacitance change	Within $\pm 20\%$ of specified value
	Internal resistance change	Less than 100% of specified value
Shelf life (65°C)	After 1500 hours no load test same as endurance	
Life Time at RT ⁽¹⁾	10 years	(1) $I\Delta C < 20\%$ and $\Delta ESR < 100\%$ of specified value, respectively and $LC <$ specified value
Cycle Life (25°C) ⁽¹⁾⁽²⁾	1,000,000 cycles	(2) Cycle : between rated voltage and half rated voltage under constant current at 25°C

● DRAWING

Unit : mm

Threaded Type

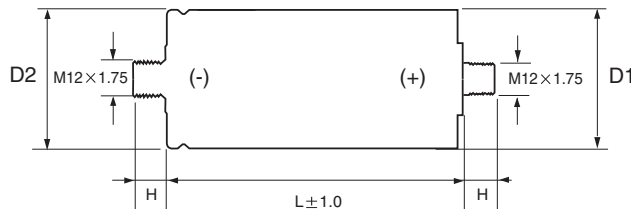
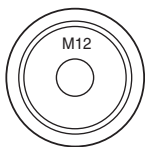

Size(mm)		
H	D1	D2
(± 0.2)	(± 0.2)	(± 0.5)
13.0	$\varnothing 60.4$	$\varnothing 60.7$

Weldable Type

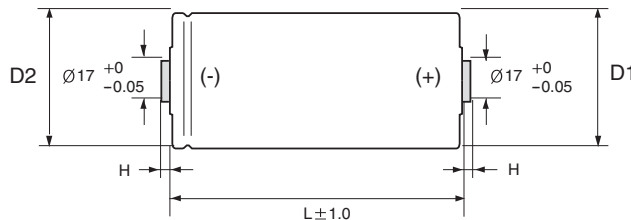

Size(mm)		
H	D1	D2
(± 0.2)	(± 0.2)	(± 0.5)
3.0	$\varnothing 60.4$	$\varnothing 60.7$

● CHARACTERISTIC LIST & DIMENSIONS

Rated Voltage	Capacitance (F)	ESR, 1KHz (m Ω)	ESR, DC (m Ω)	LC (72hr) (mA)	Max Continuous Current(A)		Max Peak Current(A)	Specific Energy		Weight (g)	Volume (ml)	Dimension $\varnothing D \times L$ (mm)
					$\Delta T=15^\circ\text{C}$	$\Delta T=40^\circ\text{C}$		(Wh/kg)	(Wh/L)			
2.85	1200	0.33	0.36	3.4	94	153	1194	4.51	6.38	300	212	60.4 × 74
	1600	0.28	0.31	4.6	109	178	1524	5.31	7.41	340	244	60.4 × 85
	2000	0.27	0.30	5.7	120	195	1781	5.64	7.72	400	292	60.4 × 102
	3000	0.20	0.23	7.0	150	245	2530	6.45	8.56	525	395	60.4 × 138
	3400	0.20	0.23	8.0	150	245	2175	7.24	9.70	530	395	60.4 × 138
3.0	3000	0.20	0.23	7.0	150	245	2663	7.01	9.48	535	395	60.4 × 138

DT Axial Type, High Temperature Series

- High Power Density
- Rapid charge and discharge
- Ultra-low internal resistance



DH \Rightarrow DT
High Temp.

Item	Characteristics	
Operating temperature range	-40 ~ +85°C	
Rated Voltage	2.5 VDC	
Capacitance tolerance	0% ~ +20%	
Temperature characteristics	Capacitance change	Within $\pm 5\%$ of initial value at +20°C
	Internal resistance change	Within 100% of initial value at +20°C
Endurance (85°C)	Test time	1500 hours
	Capacitance change	Within $\pm 20\%$ of specified value
	Internal resistance change	Less than 100% of specified value
Shelf life (85°C)	After 1500 hours no load test same as endurance	
Life Time at RT ⁽¹⁾	10 years	(1) $ \Delta CI < 20\%$ and $\Delta ESR < 100\%$ of specified value, respectively and $LC <$ specified value
Cycle Life (25°C) ⁽¹⁾⁽²⁾	1,000,000 cycles	(2) Cycle : between rated voltage and half rated voltage under constant current at 25°C

DRAWING

Unit : mm

Threaded Type

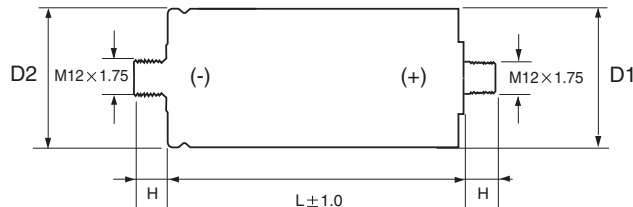
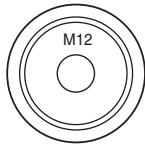

Size(mm)		
H	D1	D2
(± 0.2)	(± 0.2)	(± 0.5)
13.0	$\varnothing 60.4$	$\varnothing 60.7$

Weldable Type

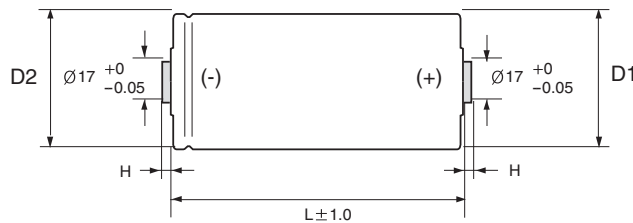
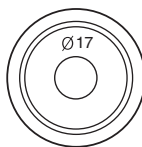

Size(mm)		
H	D1	D2
(± 0.2)	(± 0.2)	(± 0.5)
3.0	$\varnothing 60.4$	$\varnothing 60.7$

CHARACTERISTIC LIST & DIMENSIONS

Rated Voltage	Capacitance (F)	ESR, 1KHz (mΩ)	ESR, DC (mΩ)	LC (72hr) (mA)	Max Continuous Current(A)		Max Peak Current(A)	Specific Energy		Weight (g)	Volume (ml)	Dimension $\varnothing D \times L$ (mm)
					$\Delta T=15^\circ C$	$\Delta T=40^\circ C$		(Wh/kg)	(Wh/L)			
2.5	1200	0.30	0.33	2.7	98	159	1074	3.47	4.91	300	212	60.4 × 74
	1600	0.25	0.28	3.0	115	188	1381	4.08	5.70	340	244	60.4 × 85
	2000	0.24	0.27	4.0	126	206	1623	4.34	5.94	400	292	60.4 × 102
	3000	0.20	0.23	5.0	150	245	2219	4.96	6.59	525	395	60.4 × 138

Green-Cap (ELECTRIC DOUBLE LAYER CAPACITORS)

DB Snap-in Terminal Type,
Standard Series



- Endurance : 2.5V 70°C 2000 hours, 2.7V 65°C 2000 hours
- The middle size and high capacitance, low resistance
- Charge and discharge efficiency are higher than in batteries

Item	Characteristics	
Operating temperature range	-25 ~ +70°C	-40 ~ +65°C
Rated Voltage	2.5 VDC	2.7 VDC
Capacitance tolerance	-20 ~ +20% or 0% ~ +20% at 20°C	
Temperature characteristics	Capacitance change	Within $\pm 5\%$ of initial value at +20°C
	Internal resistance change	Within 50% of initial value at +20°C
Endurance (2.5V:70°C, 2.7V:65°C)	Test time	2000 hours
	Capacitance change	Within $\pm 30\%$ of specified value
	Internal resistance change	Less than 100% of specified value
Shelf life (2.5V:70°C, 2.7V:65°C)	After 2000 hours no load test same as endurance	
Life Time at RT ⁽¹⁾	10 years	(1) $ \Delta CI < 30\%$ and $\Delta ESR < 100\%$ of specified value, respectively and $LC < \text{specified value}$
Cycle Life (25°C) ⁽¹⁾⁽²⁾	500,000 cycles	(2) Cycle : between rated voltage and half rated voltage under constant current at 25°C

DRAWING

Unit : mm

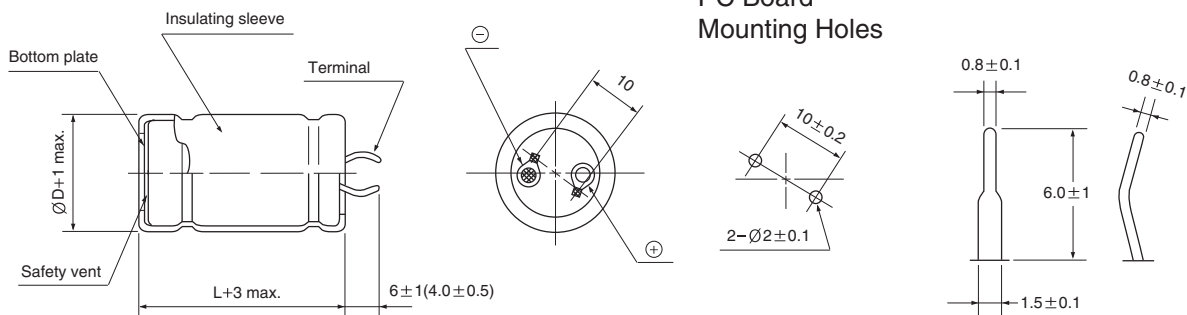

CHARACTERISTIC LIST & DIMENSIONS

Rated Voltage	Capacitance (F)	ESR, 1KHz (mΩ)	ESR, DC (mΩ)	LC (72hr) (mA)	Max Continuous Current(A)		Max Peak Current(A)	Specific Energy		Weight (g)	Volume (ml)	Dimension $\varnothing D \times L(\text{mm})$
					$\Delta T=15^\circ\text{C}$	$\Delta T=40^\circ\text{C}$		(Wh/kg)	(Wh/L)			
2.5	100	15.0	35.0	0.25	6.0	10.0	27.7	3.62	5.07	24	17	22 × 45
	200	10.0	20.0	0.50	8.0	130	50.0	4.13	5.46	42	32	30 × 45
	300	6.0	15.0	0.75	9.5	15.5	68.2	4.20	5.41	62	48	35 × 50
	360	6.0	12.0	0.90	12.0	19.5	84.6	4.17	5.41	75	58	35 × 60
	400	6.0	10.0	1.00	13.0	21.0	100.0	4.63	6.01	75	58	35 × 60
2.7	100	7.0	9.0	0.26	12.5	20.0	71.1	4.82	5.92	21	17	22 × 45
	120	7.0	9.0	0.32	12.5	20.0	77.9	5.28	6.80	23	18	22 × 47
	200	6.0	8.0	0.54	13.0	21.0	103.8	5.33	6.37	38	32	30 × 45
	300	3.5	5.0	0.81	16.0	26.5	162.0	5.33	6.31	57	48	35 × 50
	360	3.0	3.2	0.75	23.0	38.0	225.8	5.13	6.31	71	58	35 × 60
	400	3.0	3.2	0.83	23.0	38.0	236.8	5.70	7.02	71	58	35 × 60
	400	2.8	3.0	1.00	25.0	40.0	245.5	5.06	6.48	80	63	35 × 65
	450	2.8	3.0	1.00	25.0	40.0	258.5	5.18	6.77	88	67	35 × 70
	500	2.9	3.1	1.10	25.0	40.0	264.7	5.69	7.52	89	67	35 × 70
	600	3.0	3.2	1.30	25.0	40.0	277.4	6.75	9.02	90	67	35 × 70
600	2.8	3.0	1.30	25.0	40.0	289.3	6.08	7.43	100	82	35 × 85	

※ $\varnothing 35$ 4 pin type terminal drawing is same see pages.

DK Snap-in Terminal Type, High Temperature Series

- Endurance : 2.7V 85°C 1500 hours
- The middle size and high capacitance, low resistance
- Charge and discharge efficiency are higher than in batteries

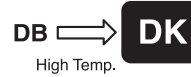

Item	Characteristics	
Operating temperature range	-40 ~ +85°C	
Rated Voltage	2.7 VDC	
Capacitance tolerance	0% ~ +20%	
Temperature characteristics	Capacitance change	Within ±5% of initial value at +20°C
	Internal resistance change	Within 50% of initial value at +20°C
Endurance (85°C)	Test time	1500 hours
	Capacitance change	Within ±30% of specified value
	Internal resistance change	Less than 100% of specified value
Shelf life (85°C)	After 1500 hours no load test same as endurance	
Life Time at RT ⁽¹⁾	10 years	(1) ΔC < 30% and ΔESR < 100% of specified value, respectively and LC < specified value
Cycle Life (25°C) ⁽¹⁾⁽²⁾	500,000 cycles	(2) Cycle : between rated voltage and half rated voltage under constant current at 25°C

DRAWING

Unit : mm

PC Board Mounting Holes

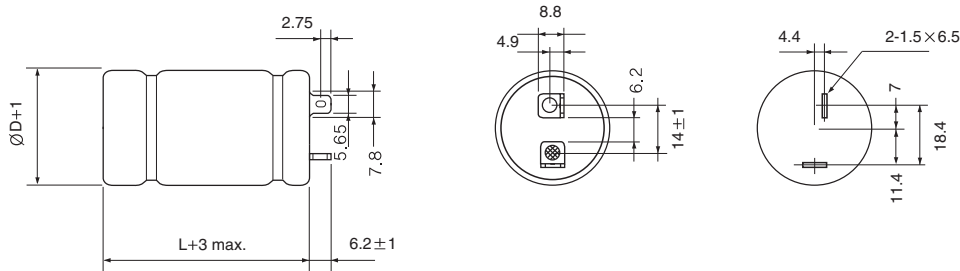

CHARACTERISTIC LIST & DIMENSIONS

Rated Voltage	Capacitance (F)	ESR, 1KHz (mΩ)	ESR, DC (mΩ)	LC (72hr) (mA)	Max Continuous Current(A)		Max Peak Current(A)	Specific Energy		Weight (g)	Volume (ml)	Dimension $\varnothing D \times L$ (mm)
					$\Delta T=15^\circ\text{C}$	$\Delta T=40^\circ\text{C}$		(Wh/kg)	(Wh/L)			
2.7	100	8.0	10.0	0.27	12.0	19.0	68	4.82	5.92	21	17	22 × 45
	200	7.0	9.0	0.54	12.5	20.0	96	5.33	6.37	38	32	30 × 45
	300	3.5	5.0	0.81	16.5	27.0	162	5.33	6.31	57	48	35 × 50
	360	3.2	3.8	0.97	21.5	35.0	205	5.13	6.31	71	58	35 × 60
	400	3.2	3.8	1.08	21.5	35.0	214	5.70	7.02	71	58	35 × 60

Green-Cap (ELECTRIC DOUBLE LAYER CAPACITORS)

DA Snap-in Terminal Type, High Voltage Series

- Endurance : 3.0V 65°C 1500 hours
- The middle size and high capacitance, low resistance
- Charge and discharge efficiency are higher than in batteries

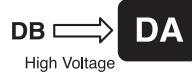

Item	Characteristics	
Operating temperature range	-40 ~ +65°C	
Rated Voltage	3.0 VDC	
Capacitance tolerance	0% ~ +20%	
Temperature characteristics	Capacitance change	Within $\pm 5\%$ of initial value at +20°C
	Internal resistance change	Within 50% of initial value at +20°C
Endurance (65°C)	Test time	1500 hours
	Capacitance change	Within $\pm 30\%$ of specified value
	Internal resistance change	Less than 100% of specified value
Shelf life (65°C)	After 1000 hours no load test same as endurance	
Life Time at RT ⁽¹⁾	10 years	(1) $I \Delta CI < 30\%$ and $\Delta ESR < 100\%$ of specified value, respectively and $LC <$ specified value
Cycle Life (25°C) ⁽¹⁾⁽²⁾	500,000 cycles	(2) Cycle : between rated voltage and half rated voltage under constant current at 25°C

DRAWING

Unit : mm

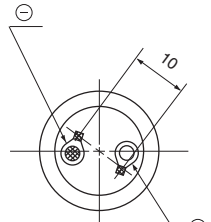
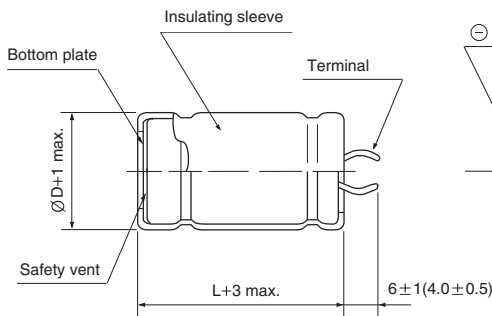

PC Board Mounting Holes

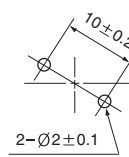

Terminal

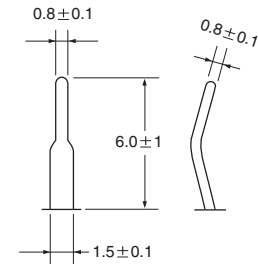

CHARACTERISTIC LIST & DIMENSIONS

Rated Voltage	Capacitance (F)	ESR, 1KHz (mΩ)	ESR, DC (mΩ)	LC (72hr) (mA)	Max Continuous Current(A)		Max Peak Current(A)	Specific Energy		Weight (g)	Volume (ml)	Dimension ØD×L(mm)
					ΔT=15°C	ΔT=40°C		(Wh/kg)	(Wh/L)			
3.0	100	7.0	9.0	0.30	12.5	20.0	79	5.95	7.31	21	17	22 × 45
	200	6.0	8.0	0.60	13.0	21.0	115	6.58	7.86	38	32	30 × 45
	300	3.5	5.0	0.90	16.0	26.5	180	6.58	7.80	57	48	35 × 50
	360	3.2	3.8	1.08	23.0	38.0	228	6.43	7.80	70	58	35 × 60
	380	3.0	3.2	1.00	25.0	40.0	257	6.60	8.23	72	58	35 × 60
	430	2.8	3.0	1.00	25.0	40.0	282	6.72	8.59	80	63	35 × 65
480	2.8	3.0	1.00	25.0	40.0	295	6.82	8.91	88	67	35 × 70	

DS Radial Type, Standard Series

- Endurance : 2.5V 70°C 1000 hours, 2.7V 65°C 1000 hours, 3.0V 65°C 1000 hours
- The small size and high capacitance, low resistance
- Can be charge and discharge more times than secondary batteries

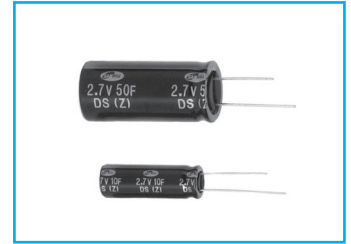

Item	Characteristics		
	Operating temperature range	-30 ~ +70°C	-40 ~ +65°C
Rated Voltage	2.5 VDC	2.7 VDC	3.0 VDC
Capacitance tolerance	0 ~ +20% at 20°C		
Temperature characteristics	Capacitance change	Within ±5% of initial value at +20°C	
	Internal resistance change	Within 50% of initial value at +20°C	
Endurance (2.5V:70°C, 2.7V:65°C, 3.0V:65°C)	Test time	1000 hours	
	Capacitance change	Within ±30% of specified value	
	Internal resistance change	Less than 100% of specified value	
Shelf life(2.5V:70°C, 2.7V:65°C, 3.0V:65°C)	After 1000 hours no load test same as endurance		
Life Time at RT ⁽¹⁾	10 years	(1) ΔCl < 30% and ΔESR < 100% of specified value, respectively and LC < specified value	
Cycle Life (25°C) ⁽¹⁾⁽²⁾	500,000 cycles	(2) Cycle : between rated voltage and half rated voltage under constant current at 25°C	

● DRAWING

Unit : mm

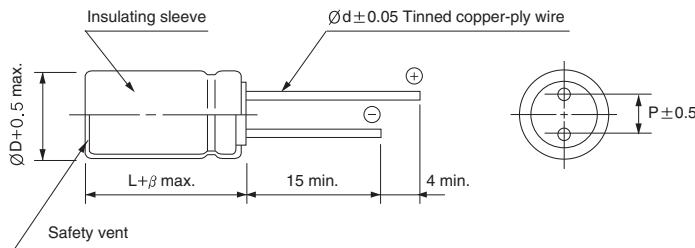

ØD	8	10	16	18
P	3.5	5.0	7.5	7.5
Ød	0.6	0.6	0.8	0.8
β	1.5		2.0	

● CHARACTERISTIC LIST & DIMENSIONS

Rated Voltage	Capacitance (F)	ESR, 1KHz (mΩ)	ESR, DC (mΩ)	LC (72hr) (mA Max.)	Specific Energy		Specific Power		Weight (g)	Volume (ml)	Dimension ØD×L(mm)
					(Wh/kg)	(Wh/L)	(W/kg)	(W/L)			
2.5	3	120	260	0.007	1.63	2.60	1,803	2,885	1.6	1.0	8 × 20
	5	70	150	0.010	1.97	2.71	2,273	3,125	2.2	1.6	10 × 20
	10	55	100	0.020	2.48	3.62	2,143	3,125	3.5	2.4	10 × 30
	25	35	65	0.020	2.89	4.34	1,538	2,308	7.5	5.0	16 × 25
	50	20	30	0.120	3.15	4.26	1,812	2,451	13.8	10.2	18 × 40
2.7	3	50	80	0.007	2.17	3.04	7,811	10,935	1.4	1.0	8 × 20
	5	45	60	0.010	2.41	3.16	6,943	9,113	2.1	1.6	10 × 20
	10	25	45	0.023	3.49	4.22	6,703	8,100	2.9	2.4	10 × 30
	15	20	40	0.030	3.38	4.90	4,860	7,055	4.5	3.1	12.5 × 25
	25	15	25	0.045	3.78	5.06	5,223	6,998	6.7	5.0	16 × 25
	33	11	20	0.060	3.34	4.13	4,374	5,400	10.0	8.1	18 × 32
	50	9	15	0.075	4.40	4.96	5,071	5,718	11.5	10.2	18 × 40
	100	8	13	0.180	4.82	5.92	3,204	3,935	21.0	17.1	22 × 45
3.0	3	60	105	0.010	2.34	3.75	6,429	10,286	1.6	1.0	8 × 20
	5	50	90	0.015	2.84	3.91	5,455	7,500	2.2	1.6	10 × 20
	10	30	45	0.030	3.57	5.21	6,857	10,000	3.5	2.4	10 × 30
	15	25	40	0.050	4.17	6.05	6,000	8,710	4.5	3.1	12.5 × 25
	25	20	30	0.070	4.17	6.25	4,800	7,200	7.5	5.0	16 × 25
	50	10	20	0.150	4.53	6.13	3,913	5,294	13.8	10.2	18 × 40

Green-Cap (ELECTRIC DOUBLE LAYER CAPACITORS)

DJ Radial Type, High Temperature Series

- Endurance : 2.5V 85°C 1000 hours
- The small size and high capacitance, low resistance
- Can be charge and discharge more times than secondary batteries

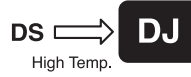

Item	Characteristics	
Operating temperature range	-40 ~ +85°C	
Rated Voltage	2.5 VDC	
Capacitance tolerance	0% ~ +20% at 20°C	
Temperature characteristics	Capacitance change	Within $\pm 5\%$ of initial value at +20°C
	Internal resistance change	Within 50% of initial value at +20°C
Endurance (85°C)	Test time	1000 hours
	Capacitance change	Within $\pm 30\%$ of specified value
	Internal resistance change	Less than 100% of specified value
Shelf life (85°C)	After 1000 hours no load test same as endurance	
Life Time at RT ⁽¹⁾	10 years	(1) $ \Delta C < 30\%$ and $\Delta ESR < 100\%$ of specified value, respectively and $LC <$ specified value
Cycle Life (25°C) ⁽¹⁾⁽²⁾	500,000 cycles	(2) Cycle : between rated voltage and half rated voltage under constant current at 25°C

DRAWING

Unit : mm

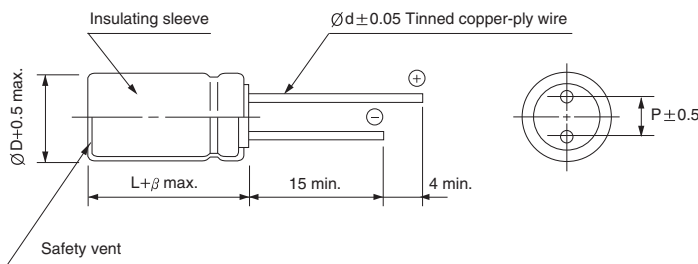

ØD	8	10	16	18
P	3.5	5.0	7.5	7.5
Ød	0.6	0.6	0.8	0.8
β	1.5	2.0		

CHARACTERISTIC LIST & DIMENSIONS

Rated Voltage	Capacitance (F)	ESR, 1KHz (mΩ)	ESR, DC (mΩ)	LC (72hr) (mA Max.)	Specific Energy		Specific Power		Weight (g)	Volume (ml)	Dimension ØD×L(mm)
					(Wh/kg)	(Wh/L)	(W/kg)	(W/L)			
2.5	3	60	105	0.008	1.63	2.60	4,464	7,143	1.6	1.0	8×20
	5	50	90	0.013	1.97	2.71	3,788	5,208	2.2	1.6	10×20
	10	30	45	0.025	2.48	3.62	4,762	6,944	3.5	2.4	10×30
	15	25	40	0.050	2.89	4.20	4,167	6,048	4.5	3.1	12.5×25
	25	20	30	0.063	2.89	4.34	3,333	5,000	7.5	5.0	16×25
	50	10	20	0.150	3.15	4.26	2,717	3,676	13.8	10.2	18×40