



Highly Focus on **INNOVATION**

WPC Product

# Calculate Ef iciency

## design flow chart with the testing equipments

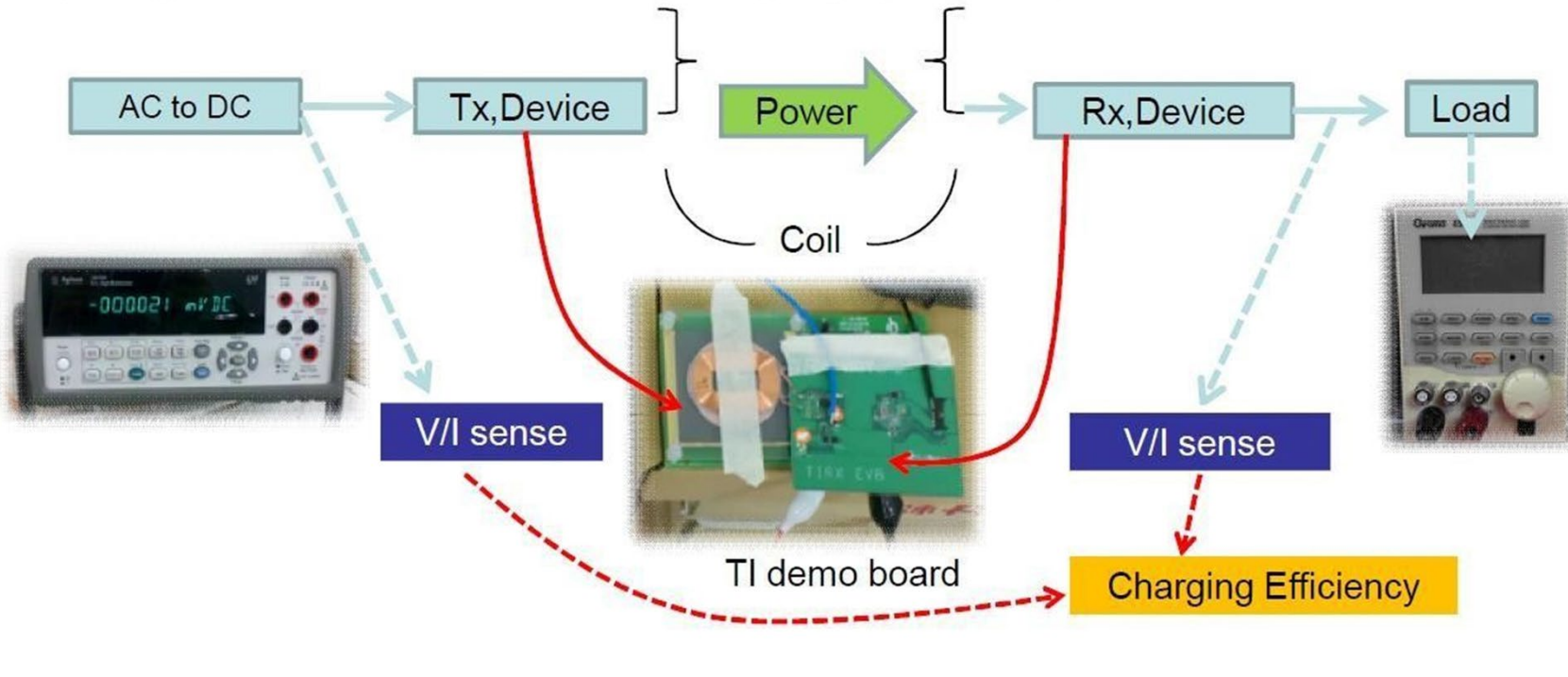

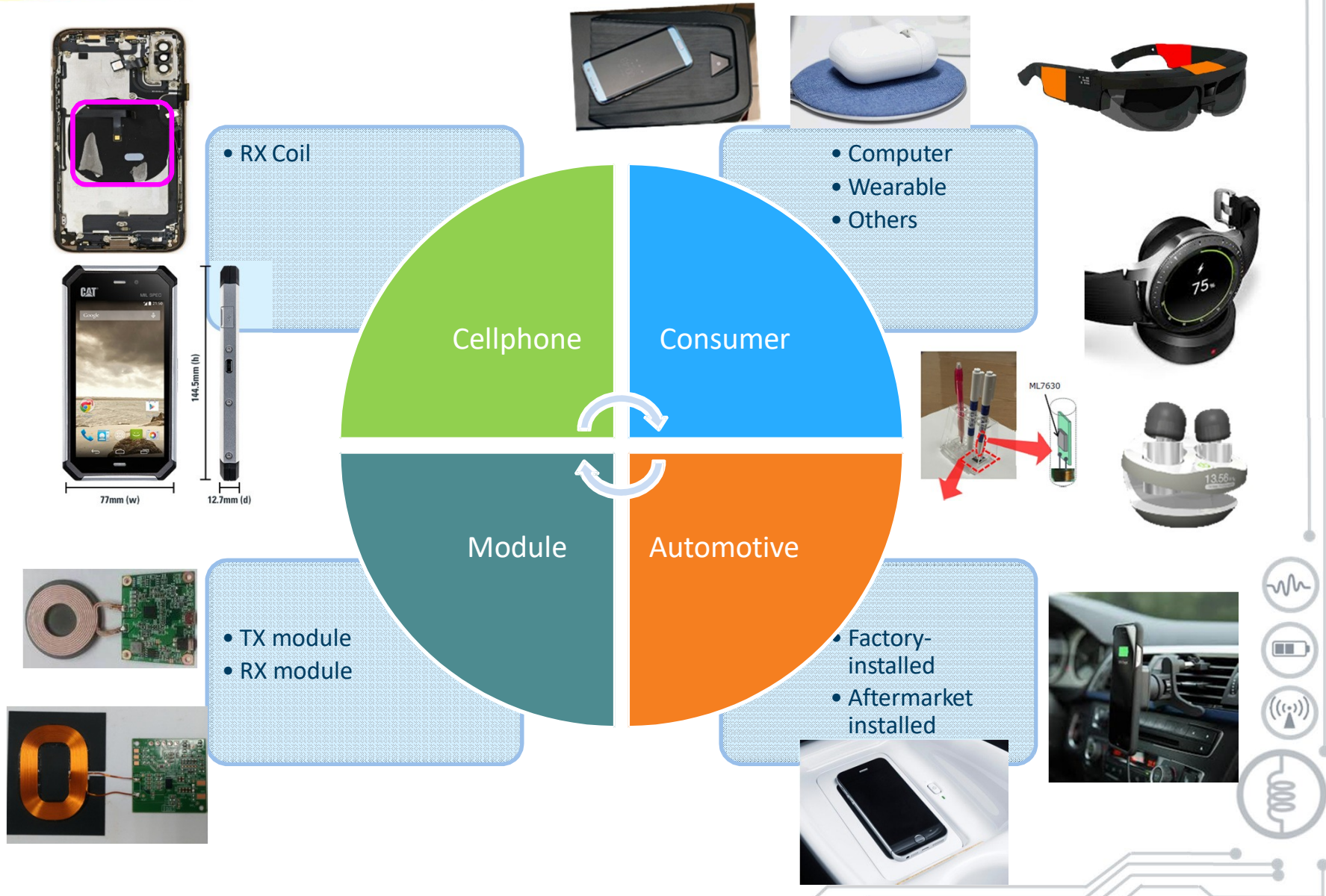

# Mobile Applications



Solution1	Solution2	
FPCBTYP	Coil TYPE	
Nanocrystalline / Mz-Zn	Nanocrystalline / Mz-Zn	
Size:50x50mm	Size:50x50mm	
Thickness:0.25~0.3mm	Thickness:0.3~0.42mm	
Power:10~15W(MAX)	Power:10~15W(MAX)	
Efficiency>80%	Efficiency>86%	
	 	
TYPE	FPCB	COIL
Material	Nano / Mz-Zn	Nano / Mz-Zn
Thickness	0.12mm	0.12mm
L	6~8uH	6~8uH
Q	14 ref.	14.8ref.
Rdc	~284 mΩref.	~150 mΩref.
Cost	High	Medium
Leadtime	Sample 15 days MP 5 weeks	Sample 15 days MP 5 weeks



# Automotive Applications

## Electrical Specification:

TestItem	TestCondition	Specification
Inductance	100KHz, 1V	12.5uH±10%(Right&Left Coil); 11.5uH±10%(Center Coil)
DCR	@25°C	65mΩ

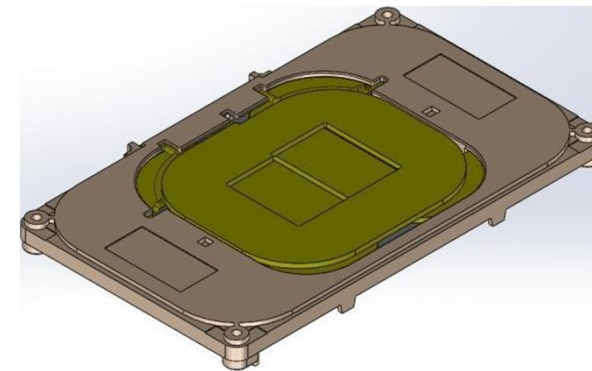
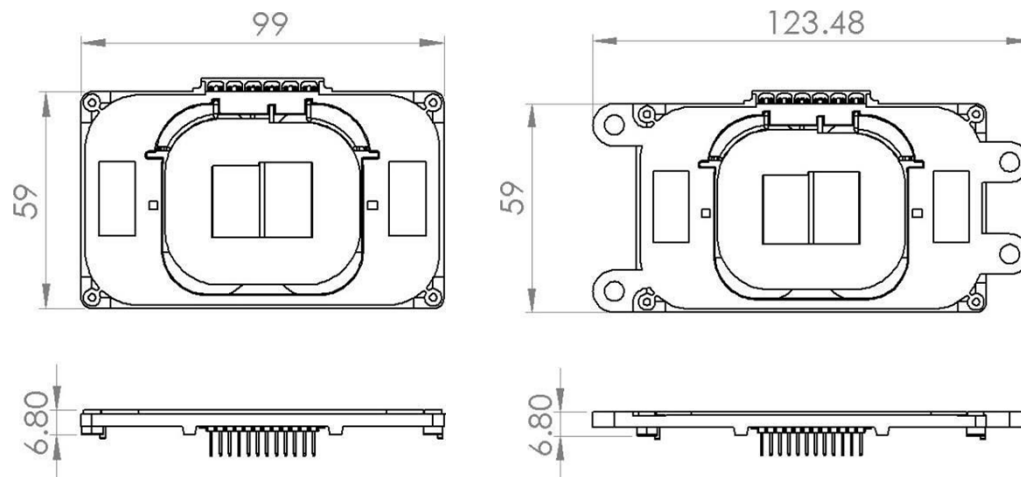

# Finish Good TX Product

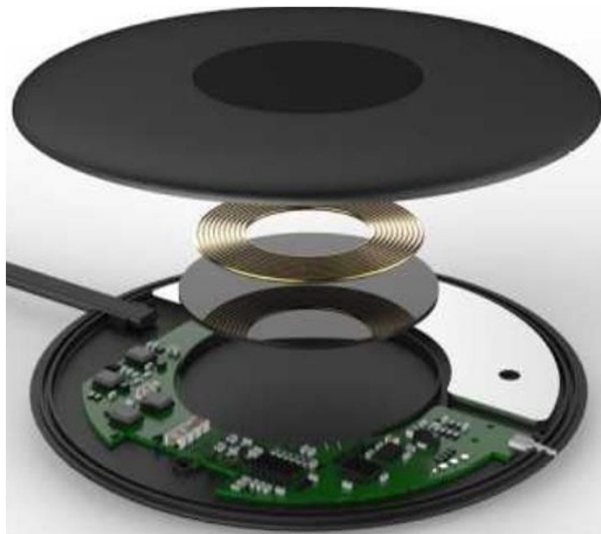

## Product Electric Features:

- (1) Power transfer up to 10W
- (2) Integrated Step-Down Switching Regulator
- (3) OCP, OVP, OTP
- (4) Input Under-Voltage Lockout
- (5) WPC-1.2.4 compliant, A11 a coil configuration
- (6) Highly integrated drivers with FETS
- (7) Foreign objects detection (FOD)
- (8) Precise frequency control
- (9) Input voltage: 5V/2A or 9V/1.11A with QC2.0up

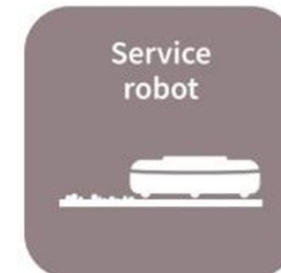

# Small Size Wireless Charger



**RX**

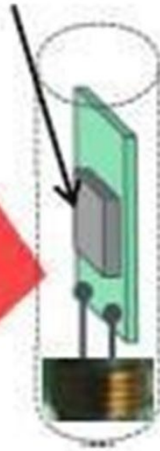

**TX**

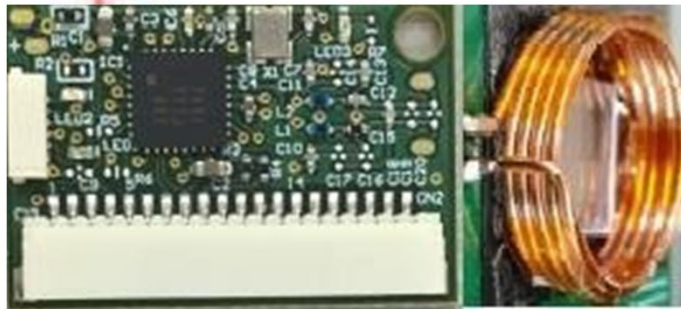

## Product Features :

- (1) Power transfer up to 200mW
- (2) **N**ear **F**ield **C**ommunication support 13.56MHz
- (3) Rx output selectable 3.5~5V
- (4) Smallest antenna size
- (5) Data communication 256 Bytes support
- (6) Single antenna support power supporter & communication



# TWS WirelessCharger



(39.6X17X0.85mm)  
L:19.5uH  
Q:10  
DCR:750mΩ

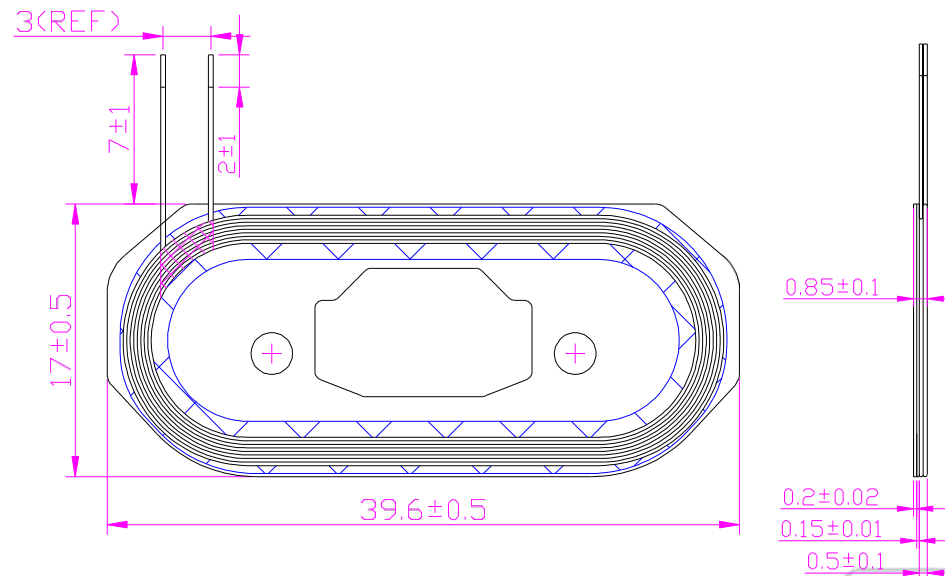
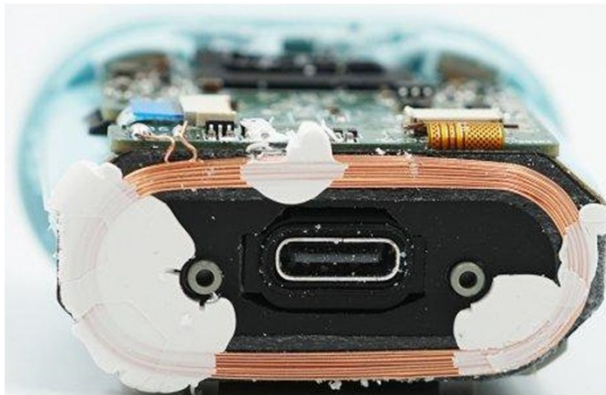



# Finish Good Automotive TX Product

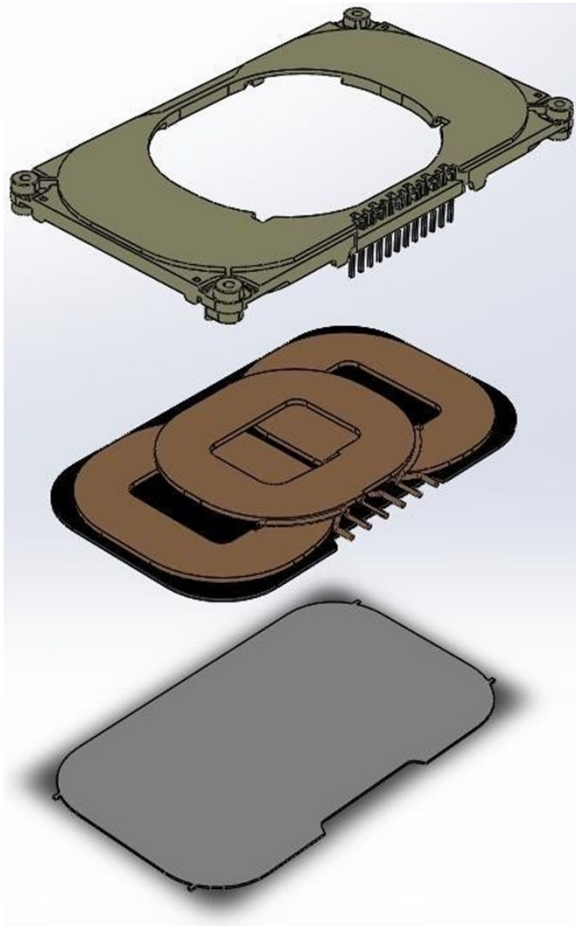

## Product Features :

- (1) WPC MP-A13 design, High permeability, high Q, low loss
- (2) A multi-coil system ensures the best possible charging.
- (3) Wireless charging embedded solution for automobile central console, arm rest...etc
- (4) Improvement of durability using housing case and metal plate
- (5) Power transfer up to 15W
- (6) Size up to 59mm\*99mm\*6.9mm
- (7) Vast operating temperature -40 °C to 125°C
- (8) Price is competitive



## RX Coil VS TX A11 Coupling Simulation



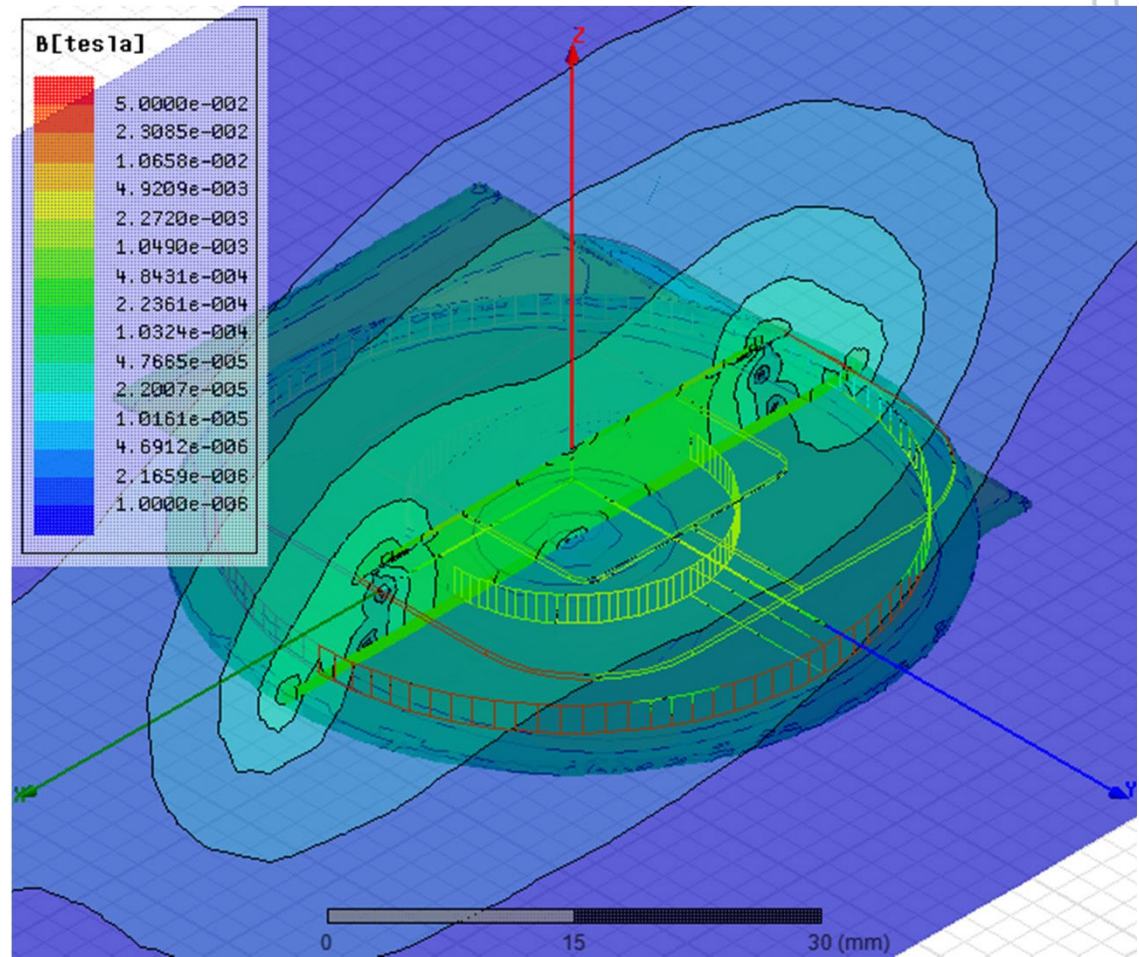



Internal Diameter	External Diameter	Coupling (K)
10.8	29.5	0.7287
13.3	32	0.75432
15.8	34.5	0.77247
18.3	37	0.78123
10.8	29.5	0.7287



# Wireless Power Transfer

Dimension: mm



Spec	Dimension (LxWxT)	Coil Inductance	Coil DCR
 2WIRE 2LAYERS/10T	ø50 x 3.8	6.3μH ±10%	25mΩ
 1WIRE 1LAYERS/12T 3 pcs/1 SET	56.5x98.3x3.5	11.5μH~12.5μH ±10%	70mΩ
 1WIRE 1LAYERS/12T	53x53x5	10μH ±10%	61mΩ
 MP-A9	101.8 x 57.3 x 4.2	9.8μH~10.2μH ±10%	65mΩ
 MP-A2 +Holder	62.3 x 58.8 x 7.4	10μH ±10%	55mΩ
 MP-A13+Holder	106 x 61.5x7.4	11.5μH~12.5μH ±10%	70mΩ



# Wireless Power Transfer

Dimension: mm



Spec	Dimension (LxWxT)	Coil Inductance	Coil DCR
Wire Coil	50 x 50 x 0.3	8.0μH±10%	170mΩ
FPC Coil	61 x 60 x 0.3	6.7μH±10%	300mΩ
Wire Coil	33 x 22 x 0.85	26.6μH±10%	1.01Ω
1WIRE 2LAYERS/30T	16 x 10 x 0.8	17μH±10%	1.03Ω
2WIRE 2LAYERS/15T	25 x 15 x 1.0	11.5μH±10%	480mΩ
2WIRE 1LAYERS/15T	43 x 33 x 0.8	12μH±10%	190mΩ
1WIRE 1LAYERS/35T	ø21 x 0.31	34.4μH±5%	3Ω
2WIRE 1LAYERS/15T	31x38 x 1	12.1μH±10%	250mΩ



# WPC TX Coil Series

**Description:**  
**Qi standard TX COIL.**

**Application:**

- **ChargerPAD**
- **TX module**
- **Power bank**
- **Automotive**

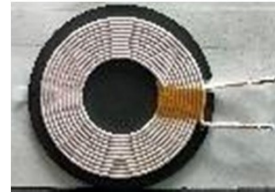

**BTWW00505024TXA005**



**BTWW00965640TXA010**



**BTWW00535340TXA014**



**BTWW00105742TXA008**

## Electrical Characteristics

Part Number	Inductance (uH, ±10%)	Test Frequency	Rdc (mΩ, ±15%)	Dimension (mm) (L*W*Tmax)	WPC TYPE
BTWW00505024TXA005	6.3	@100KHz、1V	36	ø50 x 2.8	A11
BTWW00535340TXA014	10	@100KHz、1V	50	53 x 53 x 4	MP-A2
BTWW00965640TXA010	11.5(TOP)	@100KHz、1V	65	96.4 x 56.4 x 4	A13
	12.5(BOT)	@100KHz、1V	65		
BTWW00105742TXA008	10.2(TOP)	@100KHz、1V	65	101.8 x 57.3 x 4.2	MP-A9
	9.8(BOT)	@100KHz、1V	60		



# WPC RX Coil Series

**Description:**  
**Customized RX COIL.**

**Application:**

- Cell phone
- Tablet
- Wearable device
- Battery pack



BTWW00332265RXA001

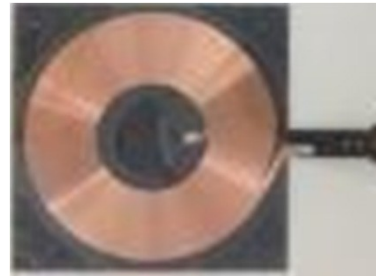

BTWW00675003RXA008

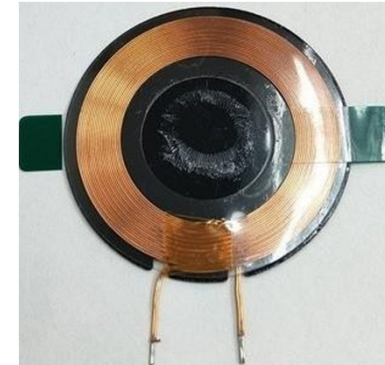

BTWWAS404048RXA003

## Electrical Characteristics

Part Number	Inductance	Q (Ref)	Test Frequency	Rdc (mΩ, ±15%)	Dimension (mm) (L*W*Tmax)
BTWW00332265RXA001	26.6	15	@100KHz、1V	900	33 x 22 x 0.85
BTWW00675003RXA008	8	23	@100KHz、1V	155	50 x 50 x 0.3 (COILAERA)
BTWWAS404048RXA003	7.5	27	@100KHz、1V	150	∅40 x 0.81



# TX Module

Photo	Classification by function	Model on	Output Power	Input Voltage	Dimensions(mm) (L*W*H)	Coil Inductance (uH @100kHz/1V)	Coil DCR
	Transfer Module	BTWM00383815TXA010	15W Max	5V/9V/12V	RX Coil: 50Φ *2.6mm RX PCB : 38*38*4.2mm	10uH±10%	55mΩ±20% (MPA2)
	Transfer Module	BTWM00505015TXA004	15W Max	5V/9V/12V	RX Coil: 50Φ*3.2mm RX PCB : 50*50*4mm	5.8uH±10%	20mΩ±20% (MPA11)



# RX Module

Photo	Classification by function	Model on	Output Power	Voltage	Dimensions(mm) (L*W)	Coil Inductance (uH @100kHz/1V)	Coil DCR
	Receiver Module	BTWM00202005RXA002	5W Max	5V/1A	RX Coil: 48*35*0.48mm RX PCB : 20*20*1.4mm	8.4uH±10%	140mΩ±15%
	Receiver Module	BTWM00402015RXA003	15W Max	5V/1A 9V/1.1A 12V/1.25A	RX Coil: 50*50*0.3mm RX PCB : 40*20*1.8mm	8uH±10%	155mΩ±15%

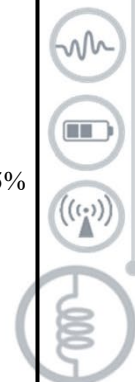



# Quality Control – Production Quality Control

Wide range of testing/measuring equipment/instrument to ensure production's performance and reliability.



RF function checking



Pull and bend tester



Drop tester



Thermo Chamber



Salt spray machine



Projector



Video Comparator



Hardness tester



Torque



RCA tester

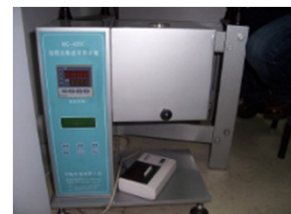

MFI tester



3D X ray



Force tester



# ELEKTRONIK **Blume**

**Wilhelm Haßenpflug**

**BLUME ELEKTRONIK DISTRIBUTION GMBH**

**TECCENTER 1 | 31162 | BAD SALZDETFURTH**

**FON:(0 50 63) 27 12-20 | FAX:(0 50 63) 27 12-12**

**EMAIL: HASSENPFUG@BLUME-ELEKTRONIK.DE**

**[WWW.BLUME-ELEKTRONIK.DE](http://WWW.BLUME-ELEKTRONIK.DE)**

partnership in excellence

