

— 2021 —

ANTI-VANDAL SWITCHES

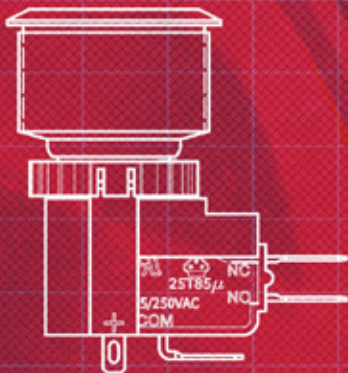

E-SWITCH®

ANTI-VANDAL SWITCH

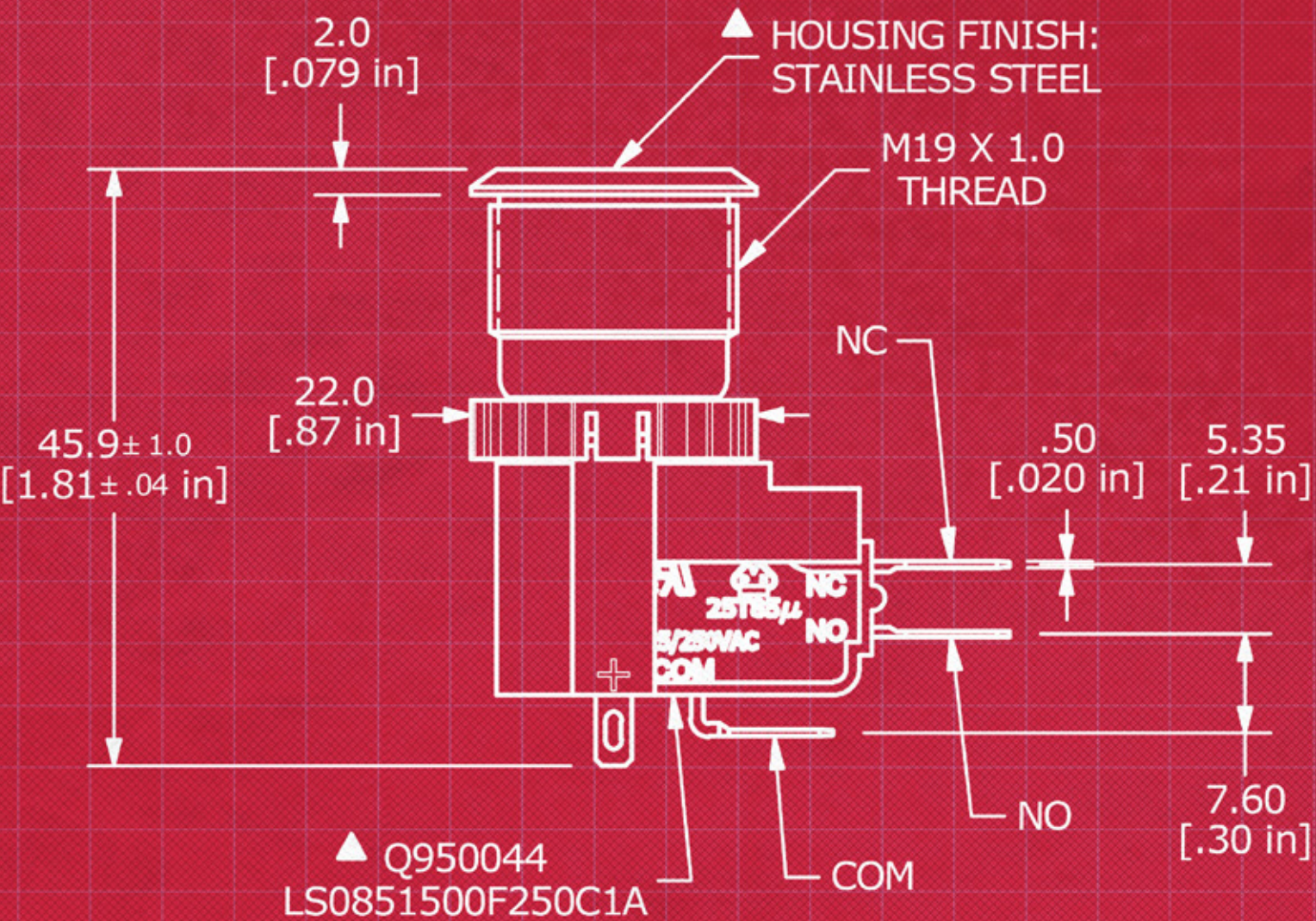









ANTI-VANDAL SWITCH





E-Switch offers a large selection of Anti-Vandal switches in the marketplace. Diameter sizes range from 6mm to 40mm, depending on the switch series. The Anti-Vandal series offer an esthetically pleasing switch due the quality housing materials and multi-illumination options in pattern style – ring, dot, power symbol, ring/power symbol combo, plus numerous choices in LED colors including bi-color and RGB. All PV switch series provide dust and moisture protection rating of IP65, excluding the PVA6 and PVL, which offer IP67 rating. A UL-certified series - ULV4, ULV 7, ULV 8 - are sealed to IP67 rating for dust and moisture resistance. Not only durable to resist damage of sharp or heavy objects, the long-life expectancy of the PV and ULV series, make these switches excellent choices for high security locations, harsh and rugged industrial-use environments. E-Switch's Anti-Vandal switches can be found in vending and parking kiosks, security control boxes, commercial appliances, industrial controls, medical equipment and transport vehicles, such as motor boats.

	Electrical Ratings	Cutout Diameter / Panel Depth	Functions Available	Terminal Options	Actuator Options	Material Options	Illumination Options	Ingress Protection	Standard Wire Lead Options
PV0	2A, 36VDC	Diameter: 12mm Max. Depth: 6mm	1 Pole: Off-(On)	Solder Lug	High	Stainless Steel Black Anodized	Dot Ring	IP65	N/A
PV1	2A, 36VDC	Diameter: 19mm Max. Depth: 8mm	1 Pole: Off-(On)	Screw Solder Lug	Domed Flat High	Black Anodized Gold Plated Brass Nickel Plated Brass Stainless Steel	N/A	IP65	N/A
PV2	2A, 36VDC	Diameter: 16mm Max. Depth: 6mm	1 Pole: Off-(On)	Screw Solder Lug	Domed Flat High	Black Anodized Gold Plated Brass Nickel Plated Brass Stainless Steel	N/A	IP65	N/A
PV3	2A, 48VDC	Diameter: 16mm Max. Depth: 8mm	1 Pole: On-(On) 2 Pole: On-(On)	Solder Lug	Flat Guarded High	Black Anodized Gold Plated Brass Nickel Plated Brass Stainless Steel	Bi-Color Dot Ring	IP67 Optional	●
PV4	2A, 24VDC .7A 125VAC (cURus)	Diameter: 19mm Max. Depth: 11mm	1 Pole: On-On On-(On) 1P Off-(On) + 1P On-(Off) 2 Pole: On-On On-(On)	Screw Solder Lug	Flat High	Black Anodized Stainless Steel	Bi-Color Dot Ring Arrow	IP65	●
PV5	2A, 36VDC	Diameter: 12mm Max. Depth: 5mm	1 Pole: Off-(On)	Screw Solder Lug	Raised Domed	Black Anodized Nickel Plated Brass Stainless Steel	N/A	IP65	N/A
PV6	2A, 48VDC	Diameter: 16mm Max. Depth: 10mm	1 Pole: Off-(On)	Solder Lug	Flat High	Black Anodized Nickel Plated Brass Stainless Steel	Bi-Color Dot Ring	IP65	N/A







Specifications subject to change without notice

	Electrical Ratings	Cutout Diameter / Panel Depth	Functions Available	Terminal Options	Actuator Options	Material Options	Illumination Options	Ingress Protection	Standard Wire Lead Options
	2A, 48VDC	Diameter: 22mm Max. Depth: 8mm (Momentary), 12mm (Maintained)	1 Pole: 1P Off-On + 1P On-Off 1P Off-(On) + 1P On-(Off)	Solder Lug	Flat	Black Anodized Nickel Plated Brass Stainless Steel	Bi-Color Dot Ring	IP65	●
	2A, 48VDC	Diameter: 25mm Max. Depth: 10mm (Momentary), 12mm (Maintained)	1 Pole: 1P Off-On + 1P On-Off 1P Off-(On) + 1P On-(Off) 2 Pole: 2P Off-On + 2P On-Off 2P Off-(On) + 2P On-(Off)	Solder Lug	Flat	Black Anodized Nickel Plated Brass Stainless Steel	Bi-Color Dot Ring	IP65	●
	2A, 48VDC	Diameter: 28mm Max. Depth: 10mm	1 Pole: 1P Off-On + 1P On-Off 1P Off-(On) + 1P On-(Off) 2 Pole: 2P Off-On + 2P On-Off 2P Off-(On) + 2P On-(Off)	Solder Lug	Flat	Nickel Plated Brass Stainless Steel	Bi-Color Dot Ring	IP65	●
	2A, 48VDC	Diameter: 40mm Max. Depth: 5mm	1 Pole: 1P Off-On + 1P On-Off 1P Off-(On) + 1P On-(Off) 2 Pole: 2P Off-On + 2P On-Off 2P Off-(On) + 2P On-(Off)	Solder Lug	Flat	Stainless Steel	Bi-Color Dot Ring	IP65	●
	2A, 36VDC	Diameter: 16mm Max. Depth: 8mm	1 Pole: On-On On-(On)	Solder Lug	Flat High	Black Anodized Nickel Plated Brass Stainless Steel	Bi-Color Ring	IP65	N/A
	2A, 36VDC	Diameter: 16mm Max. Depth: 6-8mm	1 Pole: Off-(On)	Solder Lug Wire- Lead	Rounded Flat High	Black Anodized Clear Anodized Stainless Steel Brushed Stainless Steel	Ring Power Symbol	IP67	●
	N/A	Diameter: 6-19mm Max. Depth: 6mm to 10mm (depending on mounting diameter)	N/A	Solder Lug Wire leads: 150mm	Flat	Stainless Steel Black	Pilot Lamp	IP67	●
	50mA, 24VDC	Diameter: 19mm Max. Depth: 6mm	1 Pole: Off-(On)	Solder Lug Wire- Lead	Flat	Stainless Steel	Ring	IP65	●

Specifications subject to change without notice

	Electrical Ratings	Cutout Diameter / Panel Depth	Functions Available	Terminal Options	Actuator Options	Material Options	Illumination Options	Ingress Protection	Standard Wire Lead Options
	3A 125/250VAC (cURus)	Diameter: 19mm Max. Depth: 10mm	1 Pole: On-On On-(On) 2 Pole: On-On On-(On)	Solder Lug Wire Leads: 300mm Detachable Socket Wire Leads 500mm Molded Boot Wire Leads: 500mm	Flat	Black Anodized Nickel Plated Brass Stainless Steel	Bi-Color Dot Ring Power	IP67	●
	3A 125/250VAC (cURus)	Diameter: 22mm Max. Depth: 10mm	1 Pole: On-On On-(On) 2 Pole: On-On On-(On)	Solder Lug Wire Leads: 300mm Detachable Socket Wire Leads 500mm Molded Boot Wire Leads: 500mm	Flat	Anodized Aluminum Stainless Steel	Bi-Color Ring Ring w/ Power	IP67	●
	3A 125/250VAC (cURus)	Diameter: 25mm Max. Depth: 10mm	1 Pole: On-On On-(On) 2 Pole: On-On On-(On)	Solder Lug Wire Leads: 300mm Detachable Socket Wire Leads 500mm Molded Boot Wire Leads: 500mm	Flat	Black Anodized Stainless Steel	Ring Bi-color	IP67	●



	●	●
	●	●
	●	●
	N/A	●
	N/A	●
	N/A	●

Specifications subject to change without notice

GET WIRED WITH E-SWITCH!







E-Switch offers several terminal options which will enhance your production line and your bottom line. Selecting the right terminal option for your product assembly process will provide time and costs savings from:

- No need to second-source wire leads and assembly house.
- Reduce labor cost by ordering your switches pre-wired before arrival on your manufacturing floor.
- Decrease product assembly time with the ease of installing behind the panel.

The Anti-Vandal switch (a.k.a. Vandal-Resistant, Vandal-Proof, Tamper-Resistant or Tamper Proof) was designed to be installed in devices and equipment that are susceptible to harsh use, vandalism, theft, as well as withstand extreme temperatures and be resistant to dust and moisture. The wired options are color-coded for convenience and are compatible with a variety of connectors.

Head to e-switch.com/get-wired-with-e-switch to find out more about our wired options.



	Electrical Ratings	Cutout Diameter / Panel Depth	Functions Available	Terminal Options	Actuator Options	Material Options	Illumination Options	Ingress Protection	Standard Wire Lead Options
	15A @ 125/250VAC	Diameter: 19mm Max. Depth: 1-11mm	1 Pole: 1P - ON - ON, 1P ON - (ON) Momentary	4.8 mm Quick Connect	Flat	Stainless Steel, Black Anodized	Non-illuminated, Dot, Ring, Power Symbol, Ring/Power Symbol Combo	IP67	N/A
	15A @ 125/250VAC	Diameter: 22mm Max. Depth: 1-11mm	1 Pole: 1P - ON - ON, 1P ON - (ON) Momentary	4.8 mm Quick Connect	Flat	Stainless Steel, Black Anodized	Non-illuminated, Ring, Ring/ Power Symbol Combo	IP67	N/A
	15A @ 125/250VAC	Diameter: 25mm Max. Depth: 1-11 mm	1 Pole: 1P - ON - ON, 1P ON - (ON) Momentary	4.8 mm Quick Connect	Flat	Stainless Steel, Black Anodized	Non-illuminated, Ring, Ring/Power Symbol Combo	IP67	N/A
	2A 2 36VDC	Diameter: 19mm Max. Depth: 1-6mm	1 Pole: SPST 1P OFF - (ON)	Solder Lug, Wire Leads: 500mm	Flat	Stainless Steel	Ring, Ring/Power Symbol Combo	IP67	●
	2A 2 36VDC	Diameter: 22mm Max. Depth: 1-6mm	1 Pole: SPST 1P OFF - (ON)	Solder Lug, Wire Leads: 500mm	Flat	Stainless Steel	Ring, Ring/ Power Symbol Combo	IP67	●
	2A 2 36VDC	Diameter: 25mm Max. Depth: 1-6mm	1 Pole: SPST 1P OFF - (ON)	Solder Lug, Wire Leads: 500mm	Flat	Stainless Steel	Ring, Ring/Power Symbol Combo	IP67	●
	2A @ 24VDC	Diameter: 22mm Max. Depth: 1-11mm	SPDT, DPDT	Solder Lug, Wire Leads: 300mm	Flat	Stainless Steel	Ring	IP65	●

Specifications subject to change without notice



Specifications subject to change without notice



E-SWITCH®

ABOUT US

E-Switch, headquartered in Minneapolis, Minnesota, has been delivering quality electromechanical switches to the telecom, high tech, medical, electronics, instrumentation, industrial, audio/visual, appliance and consumer markets since 1979. With international offices in Singapore and Hong Kong, E-Switch's global reach includes North America, Europe, Asia and Latin America.

E-SWITCH, INC.

ADDRESS: 7153 NORTHLAND DRIVE N
MINNEAPOLIS, MN 55428-1514
USA

PHONE: 763-504-3525
TOLL FREE (USA): 800-867-2717
FAX: 763-531-8235

E-SWITCH ASIA

ADDRESS: 8 BURN ROAD
#09-14, TRIVEX
SINGAPORE 369977

PHONE: +65 6909 0863

WWW.E-SWITCH.COM



@ESwitch



E-Switch, Inc



@EswitchSwitches



E-Switch, Inc



eswitch.wordpress

2021 E-Switch, Inc. All rights reserved. E-switch Inc. is a wholly-owned subsidiary of Stein Industries, Incorporated